



# FORMICA® Products

## fabrication advice 2012

INTRODUCTION	3
GENERAL INFORMATION	4
SURFACE FINISH	5
GRADES	6
PERFORMANCE STANDARDS	8
RESISTANCE TO CHEMICALS	8
THERMAL PROPERTIES	9
MAINTENANCE AND CLEANING	10
FABRICATION	13
HANDLING	13
STORAGE	13
PRE-CONDITIONING	14
COUNTER VENEERING AND BOARD FLATNESS	15
SUBSTRATES (CORE BOARDS)	16
ADHESIVES	18
POSTFORMING	19
SUBSTRATES FOR USE IN POSTFORMED COMPONENTS	22
FORMICA® POSTFORMING PRODUCTS	23
MACHINING POSTFORMING COMPONENTS	24
CORNER JOINTING	24
MACHINING	25
HAND TOOLS	27
EDGING	28
APPLICATION	29
DESIGN CONSIDERATIONS	29
SURFACE FINISH	29
STRESS CRACKING	30
ADHESIVE BOND FAILURE (BUBBLING)	31
FIXING AND JOINTING COMPOSITE BOARDS	32
DOOR CLADDING	34
EXTERIOR USE (STANDARD)	35
FORMICA LAMINATE USED A WRITING SURFACE (DRYWIPE BOARD)	36
SPECIAL PRODUCTS - FORMICA COMPACT GRADE LAMINATE	37
COMPACT LAMINATES IN WET AREAS	41
COLORCORE®	42
DECOMETAL®	46
FORMICA MAGNETIC LAMINATE	52
SPECIFICATION CLAUSES	57

**FORMICA GROUP** has always been at the forefront of the decorative laminate industry and, today, Formica® laminate is more beautiful and more versatile than ever. It is specified by interior designers, architects, shopfitters, builders, furniture makers and other fabricators because it offers an attractive and durable finish.

The wide range of designs and colours, the variety of grades, adhesives and substrate possibilities, and the different surface textures and finishes available make proper specification and fabrication paramount to successful end-use.

This Fabrication Guide provides a quick and easy reference to assist specification and fabrication, from choosing the correct grade through to design considerations and cleaning of laminates in use.

Whilst this Fabrication Guide is designed to make specification easier, it is not intended to discourage personal contact with Formica Group. Our technical department, Fabrication Support Unit and Sales departments are ready to provide assistance in specification and fabrication to assure the successful use of Formica decorative laminate.

### **IMPORTANT NOTE**

All information presented in this manual is given subject to the current Conditions of Sale of Formica Group. This manual is only a general guide to good practice and constitutes no form of warranty or representation as to fitness for purpose in respect of the products and processes described in it. Formica Group is engaged in a continuing programme of research and development and at least every six months users should check whether Technical Information has been updated.

Nothing in this manual should be construed as a grant or an offer to grant any rights in any products owned by or licensed to Formica Group.

Formica, the Formica anvil device, DecoMetal, ColorCore, AR Plus and Vivix are registered trademarks of The Diller Corporation. © 2012 The Diller Corporation. A Fletcher Building Company. The company reserves the right to change specification at any time without prior notice.

# GENERAL INFORMATION

## **COMPOSITION**

High pressure decorative laminates are ready-finished man made veneers of high density.

Formica® decorative laminates consist of layers of specially selected papers, impregnated with thermosetting synthetic resins, fused together under heat and very high pressure.

The surface layer(s), incorporating decorative colours or designs, are impregnated with melamine-based resins to give high resistance to wear, impact, heat and staining.

The core layers are impregnated with phenolic-based resins for strength and flexibility.

## **SHEET SIZES**

Formica decorative laminates are available in a comprehensive range of sheet sizes.

Availability is related to grade and surface finish. For full details please check the Collection Availability programme.

## **WEIGHT**

As a general guide Formica decorative laminates weigh 1.45 kilograms per square metre per millimetre of thickness of the sheet.

# SURFACE FINISH

## **GENERAL**

Formica® decorative laminates are available in a variety of different surface textures and finishes. Some of these are available over a number of ranges, whilst others are integral to particular designs and patterns.

Choice of surface finish is important from a functional as well as an aesthetic point of view. In general, textured surfaces and light colours have a better scuff and scratch resistance than plane surfaces and dark colours. For this reason, glossy laminates and dark plain colours are not recommended for heavy duty working surfaces. On the other hand, plane and lightly textured surfaces are more easily cleaned than deeply textured finishes.

## **FORMICA® DECOMETAL**

Polished aluminium items have anodised surfaces for improved resistance to oxidation, scratches, staining, etc.

Other aluminium items have an epoxy coating, and copper finishes are protected with polyurethane lacquer.

Under certain fluorescent lighting conditions the polished finishes may show an iridescent effect.

# GRADES

Description	Grade	Performance Category	Typical Applications
Horizontal, General purpose, Standard	HGS	Materials of high performance for general use in horizontal, interior applications and for use in vertical, interior applications requiring particularly high performance.	Kitchen and commercial work surfaces, restaurant and hotel tables, doors and wall coverings, heavy duty interior walls of public transport vehicles.
Horizontal, General purpose, Postforming	HGP	Similar to HGS, but can be heated and formed under controlled conditions.	As for HGS, where curved details are required.
Horizontal, General purpose, Flame retardant	HGF	Similar to HGS, but also meeting specified fire performance requirements.	Areas requiring compliance with fire performance requirements specified in construction, transport and marine fire safety regulations.
Vertical, General purpose, Standard	VGS	Materials of less high performance than HGS for general use in vertical, interior applications and for use in some horizontal applications where only moderate performance is required.	Kitchen front panels, wall coverings, shower panels, shelves.
Vertical, Flame retardant, Postforming	VFP*	Similar to VGS, but meeting specified fire performance requirements and can be heated and formed under controlled conditions.	Areas requiring compliance with fire performance requirements specified in construction, transport and marine fire safety regulations and where curved details are required.
Pearlescent, thin decorative design laminate, Postforming	ATP	Materials having special decorative effects, typically pearlescent, with lower wear resistance, for general use in vertical, interior applications.	Kitchen front panels, wall coverings etc., where curved details are required.
Coloured core, thin high pressure laminate, Standard	BTS	Materials of high performance for general use in horizontal, interior applications and for use in vertical, interior applications requiring particularly high performance and where edge and surface detailing are important.	Kitchen and commercial work surfaces, restaurant and hotel tables, doors and wall coverings, heavy duty interior walls of public transport vehicles.
Metallic, thin decorative design laminate, Postforming	MTP	Materials having special decorative effects, typically real metal surfaces, with lower wear resistance, which can be heated and formed under controlled conditions, for general use in vertical, interior applications.	Kitchen front panels, wall coverings etc., where curved details are required.

## GENERAL

Formica Group produce the above grades of decorative laminate each with its own performance characteristics.

These grades conform to EN 438-2:2005 and are suitable for the typical applications shown.

Description	Grade	Performance Category	Typical Applications
Metallic, thin decorative design laminate, Flame retardant	MTF	Materials having special decorative effects, typically real metal surfaces, with lower wear resistance, but also meeting specified fire performance requirements, for general use in vertical, interior applications.	Areas requiring compliance with fire performance requirements specified in marine fire safety regulations.
Compact, General purpose, Standard	CGS	Thick materials, of high performance for use in interior applications requiring high impact and moisture resistance.	Washroom cubicles, partitions, laboratory bench tops, work surfaces and various self-supporting components in construction and transport applications
Compact, General purpose, Flame retardant	CGF	Thick, high performance materials for use in interior applications, meeting specified fire performance requirements.	Areas requiring compliance with fire performance requirements specified in construction and transport fire safety regulations.
Exterior grade, Moderate use, Standard	EGS	Thick, high performance materials meeting specified UV and weather resistance requirements, for general use in exterior cladding applications involving medium term exposure to average levels of sunlight and weathering.	Exterior cladding applications and related areas, soffits, balcony panels, decorative screening and infill panels where moderate levels of UV and weather resistance are required.
Exterior Grade, Moderate use, Flame retardant	EGF	Thick, high performance materials meeting specified UV and weather resistance requirements and specified fire performance requirements, for use in general exterior cladding applications involving medium term exposure to average levels of sunlight and weathering.	Areas requiring compliance with fire performance requirements specified in construction fire safety regulations and where moderate levels of UV and weather resistance are required.
Exterior Grade, Severe use, Standard	EDS	Thick, high performance materials meeting specified UV and weather resistance requirements, for use in exterior ventilated rainscreen façade applications involving long term exposure to strong sunlight and weather.	Ventilated rainscreen façade applications and related areas, soffits, balcony panels, decorative screening and infill panels where high levels of UV and weather resistance are required.
Exterior Grade, Severe use, Flame retardant	EDF	Thick, high performance materials meeting specified UV and weather resistance requirements and specified fire performance requirements, for use in exterior ventilated rainscreen façade applications involving long term exposure to strong sunlight and weather.	Ventilated rainscreen façade applications and related areas requiring compliance with fire performance requirements specified in construction fire safety regulations and where high levels of UV and weather resistance are required.

The references above denote the product classification system contained in EN 438-2. Each grade has specific properties suitable for specific applications. Flame retardant laminates meet the fire performance requirements specified for Transport, Building Products (Euroclass) and the specified National Standards, for example, Class 1 (BS 476-7), B1 (DIN4102-1), M1 (NF P92-501 & UNE23727). DecoMetal laminates and Formica HGP grade laminates meet the requirements for Marine (IMO/MED). For further information on fire performance and certification please contact your regional Formica Group Technical Department.

\*VFP does not appear in the EN 438-2 : 2005 classification system.

# PERFORMANCE STANDARDS

Formica® decorative laminates are produced to conform to EN 438-2:2005 and ISO 4586. These standards define the performance of the various grades of laminate, in relation to their application.

For example, the wear resistance specified for horizontal grade laminates is higher than that for vertical grade laminates.

To conform to these specifications, laminates are required to be tested for:

- Resistance to surface wear
- Resistance to boiling water
- Resistance to dry heat
- Dimensional stability
- Resistance to impact
- Resistance to cracking
- Resistance to scratching
- Resistance to stains
- Resistance to colour change in artificial light
- Resistance to cigarette burns
- Resistance to steam
- Post formability
- Reaction to fire

# RESISTANCE TO CHEMICALS

For information on performance values relating to particular grades of laminate, please contact our Technical Services Department.

Formica® laminates have been widely and satisfactorily used for many years in laboratories in medicine and industry. They easily meet the requirements of EN 438-2:2005, which specifies resistance to staining by over 40 substances which are likely to be encountered in everyday use.

These include tea, coffee, milk, citric acid, acetone, alcohol, fruit juices, detergents, bleaches and colouring agents, but do not include chemicals more likely to be found in laboratories.

The chart below shows the effects of contact with some of the more aggressive materials commonly used in laboratories.

Performance	Chemical
No effect after 16 hours contact time.	Acetic acid, acetone, ammonia, alcohol, amyl acetate, benzene, butyl acetate, carbon tetrachloride, caustic soda (solutions less than 10%), citric acid, detergents, olive oil, paraffin, phenol, petrol, soaps, sugar solutions, toluene, xylene.
No effect if completely removed within 10-15 minutes.	Caustic soda (solutions greater than 10%), ferric chloride, formic acid, hair dyes, hypochlorite bleach, hydrochloric acid (less than 10%), hydrogen peroxide (less than 30%), iodine, nitric acid (less than 10%), oxalic acid, phosphoric acid (less than 10%), potassium permanganate, silver nitrate, sulphuric acid (less than 10%).
Permanent staining or surface attack probable, necessitating immediate removal.	Hydrochloric, nitric, phosphoric and sulphuric acids in concentrations greater than 10%.

Chemtop®2 technology features an advanced chemical resistant surface that is ideal for high stress environments where relatively harsh acids, alkalis, corrosive salts and other destructive or staining substances are used.

Offered in 16mm compact grade and postforming grade laminate. Chemtop2 is easy to fabricate, extremely durable and requires little maintenance, resulting in exceptionally low-life cycle cost.

For information on resistance to specific chemicals please contact your local Formica Sales Office.



# THERMAL PROPERTIES

## **DRY HEAT**

Formica® decorative laminates will withstand surface temperatures of up to 180°C (356°F) for short periods without deterioration of surface or colour (although in some cases a slight loss of gloss may occur) but continuous localised heat must be avoided.

It should be noted that cooking vessels can achieve much higher temperatures in normal usage, e.g. the base of a pan containing cooking fat can exceed 250°C, which is why it is recommended that hot pans etc. should not be placed directly onto laminate faced work surfaces.

When used in situations involving localised heat, e.g. adjacent to ovens etc, the maximum temperature to which the laminate should be subjected for long periods (up to 8 hours) is 100°C. There are other applications, such as the use in fire surrounds, where laminates are subjected to direct heat more or less continuously.

In such cases, the surface temperature should not be allowed to exceed 60°C, and heat resistant adhesives should be used to prevent lifting of the laminate from the substrate. In addition, design details should be carefully considered to avoid panel distortion and cracking from the internal corners of cut-outs.

## **RESISTANCE TO CIGARETTE BURNS**

Formica decorative laminates have a good resistance to damage by lighted cigarettes, and will normally only suffer a loss of gloss and/or slight to moderate brown staining; however, excessive localised heating can result in blistering of the laminate surface and it is therefore prudent to avoid direct contact with burning cigarettes or cigars.

## **RESISTANCE TO BOILING WATER**

Formica decorative laminates are resistant to steam and boiling water and are therefore ideal for applications where cleanliness and hygiene are important factors.

## **COLD**

Formica decorative laminates are unaffected by extreme dry cold and cold storage conditions.



# MAINTENANCE AND CLEANING

## **FORMICA® LAMINATES**

Formica® decorative laminates do not easily scratch or chip and will withstand normal wear and tear, but should never be used as a cutting or chopping surface.

They will resist the effects of vandalism and, properly fabricated, will provide very durable surfaces suitable for public areas.

Laminate surfaces are best kept clean using water and mild detergent. Non-scratch liquids or creams are recommended for stubborn stains.

More persistent marks and discolouration (for example after long term exposure to tobacco smoke or industrial grime) can usually be removed by careful use of a mild abrasive cream or paste cleaner, however on no account should scouring pads or harsh abrasive cleaning agents be used.

Ink marks from felt-tip and ball-point pens can be removed with a suitable solvent (e.g. methylated spirits, acetone, etc.) on a clean cloth. Organic solvents such as white spirit and cellulose thinners can also be used to remove paint splashes and graffiti, as they will not affect the laminate surface.

Acid based ceramic cleaners and limescale removers must not be used as they can cause permanent staining. Any spillage or splashes of these cleaners must be washed off the laminate surface immediately.

After using a cleaner, the surface should be rinsed with clean water and polished dry with a soft cloth.

Proprietary window-cleaning products are excellent for avoiding and removing drying marks and smears on the final finish.

Furniture polishes should not be used, as a build up of silicone wax on the surface may result causing eventual discolouration and smear marks which can be very difficult to remove.

Because of the nature of the surface, deep textured finishes are inevitably more difficult to clean than smooth surfaces and light textures. For stubborn marks in textured surfaces a nylon bristle brush can be used in conjunction with any of the above cleaners to remove deep-seated stains and marks.

### **AR Plus®**

AR Plus laminates should be cleaned with warm soapy water or mild household detergent solution and a soft cloth. Abrasive cleaners must not be used.

Solvent cleaners must be used with care and should be tried first on a scrap off-cut to ensure that no surface damage results.

### **DecoMetal®**

DecoMetal laminates should be cleaned with warm soapy water or mild household detergent solution and a soft cloth. Abrasive cleaners must not be used.

Solvent cleaners must be used with care and should be tried first on a scrap off-cut to ensure that no surface damage results.

Solvents must not be used on products having polyurethane lacquer finishes.

### **Chemtop®2**

Formica Chemtop2 laminate surfaces may be cleaned with a damp cloth and mild detergent. Use of abrasive cleaners, powders, scouring pads, steel wool, sandpaper, etc., will damage the finish and can permanently reduce the stain and chemical resistance of the laminate. Good laboratory practice dictates that all chemical spills should be wiped up promptly. Stubborn stains may be removed by use of organic solvent or hypochlorite bleach, followed by wiping with a soft, damp cloth. If in doubt about the suitability of a particular cleaner or detergent, check with the manufacturer of the cleaning product.

## CLEANING REQUIREMENTS

	Dust, dirt, dust/grease mixture, pencil, chalk	Chalk residue, chalk rims, (water rims), rust	Coffee, tea, fruit juice, sugar solutions	Grease, oil, finger-marks, felt-pen, marker-pen, ballpoint pen, nicotine deposits, tea leaves, rubber marks	Wax residues, candle-grease, wax crayon	Lipstick, shoe polish, floor polish, wax polish	Bacteriological stains, soap residues, skin excretions, germs, blood, urine, vomit	Dark patches appearing after treatment with solvents	Water colours, corrosives, Disperse dyes, water-soluble adhesives	Solvents containing varnishes, dyes and adhesives, varnish residues, varnish sprays, colour sprays, marking inks	Dual-constituent varnishes and adhesives, synthetic resins	Silicone sealants, furniture polish
Light, recent marks	Use paper towels; soft, clean cloths (dry and damp; sponge or similar). After using a damp cloth, wipe down afterwards with adsorbent paper towels.											
Normal soiling of longer duration	Use clean hot water, clean water or towels, soft sponge or brush (eg nylon brush). Use normal non-abrasive cleaning agent, washing powder (especially heavy-duty clean water detergent), liquid soap or hard soap. Remove dirt with solution of cleaning agent, or let it soak according to the degree of soiling, then wash off with clean water or glass cleaner. Wipe several times if necessary. Remove all traces of cleaning agent, to prevent streaks developing. With clean, absorbent cloths (or better still, paper towels) wipe the surface dry. Change cloths frequently.											
					Organic solvents (eg acetone, spirits, petrol, trichlorethylene, MEK). Nail varnish remover.		Can be steam cleaned. Disinfect as appropriate.		Water or organic solvent.	When using adhesives or varnishes in manufacturing, consultation with the makers is recommended to discover the cleaning agents best suited for removing soiling which might occur during fabrication.	Cleaning is possible only before hardening takes place. Remove at once after contact using water or organic solvent.	Silicone remover.
Hard, stubborn marks, old stains	Soak dirt overnight in washing-up liquid or solution of washing powered in water. Then use liquid detergent in conjunction with a fine cutting/polishing compound. Gentle bleach may be used, but with great caution. NB Use liquid detergent, cutting/polishing compound, or bleach, as seldom as possible!											
		Certain chalk residues may be removable by an acidic cleaning agent (eg 10% acetic or citric acid.							Soften with water or organic solvent, then peel or pull off.	No cleaning possible! Residues of condensation adhesives or reagent adhesives can no longer be removed.		

# FABRICATION

## HANDLING

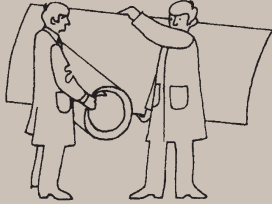

Care should be taken when handling decorative laminates to avoid breakages and damage.

When loading and unloading, sheets should be lifted, not slid. Abrasion between decorative faces should be avoided.

Individual sheets should be carried with the decorative face towards the body.

Sheets become rigid and thus easier to handle if they are bowed along the longitudinal axis. Large sheets should always be handled by two men.

Sometimes it is convenient, especially with thinner grades of laminate, to roll the sheet, decorative face inward, into cylinder of approximately 600mm diameter.

All DecoMetal® laminates should be transported and stored flat, it is not recommended to roll these laminates for transport.

When transporting stacks of sheets with mechanical handling vehicles, pallets of adequate size and rigidity should be used.

## STORAGE

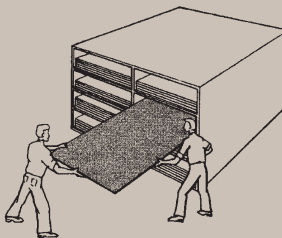

Formica® decorative laminates should preferably be stored face to face, flat in horizontal racks. The use of a cover board for covering the top sheet and keeping it flat is recommended. If this is impractical, the top sheet should be turned decorative face downwards, to prevent surface damage and warping.

Where horizontal storage is not possible or where only small stocks of assorted colours and patterns are kept, these can be stacked on edge in slightly inclined vertical racks with support over the entire surface area and a cover board to prevent sliding.

The recommended angle for such racks is approximately 80° from the horizontal.

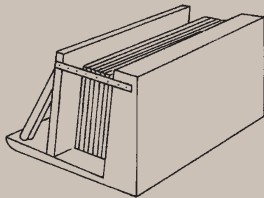

Decorative laminates should always be kept in an enclosed dry store together with corresponding substrate materials, backing boards and adhesives, at a temperature of not less than 18°C (65°F). When materials are brought into a workshop from temperatures or humidity levels different from ambient (e.g. after delivery), they should be allowed to stabilise before fabrication. Usually a minimum of three days is required.

See section on pre-conditioning for further information on storage prior to fabrication.

# PRE-CONDITIONING

The most important factor in achieving stability in bonded panels is the pre-conditioning of core materials, surfacing and backing laminates prior to bonding.

Pre-conditioning ensures that the effects of differential movement, caused by the materials' reaction to changes in relative humidity, are minimised.

The following procedure will allow the laminates to reach equilibrium; any subsequent movement, caused by changes in humidity, will then be equal on each side of the bonded panel and the risk of bowing will be greatly reduced.

Decorative laminates and core materials should be conditioned before bonding so that all materials reach equilibrium and are neither too dry nor too damp, the latter being most important at the time of pressing. Optimum conditions are best achieved in a dry storage area (about 20°C and 50-60% Relative Air Humidity).

The sheets that will form the opposite faces of the same composite board are best conditioned as a pair, with their sanded backs together. Sheets paired in this manner should be stacked, covered, and left for a minimum period of three days in order to reach moisture equilibrium. This will ensure that they achieve near identical moisture contents prior to so that bonding, and any subsequent dimensional movements will therefore be similar in both magnitude and direction on each side of the composite panel.

Wood-based core materials should have a moisture content of around 9%. The moisture content of laminates cannot be measured with a normal moisture meter, but it is essential that the face laminate has the same moisture content as the corresponding backing board.

If the composite boards are to be exposed to constant low relative humidity in their subsequent application (e.g. radiator casings), the laminates and core materials should be pre-conditioned in warm dry conditions for a suitable period in order to pre-shrink the materials and so avoid any subsequent shrinkage stresses.

Panels and boards faced with decorative laminate will nearly always be required to have the reverse side faced with a similar material to counter-balance the effects of dimensional changes that may take place.

# COUNTER VENEERING AND BOARD FLATNESS

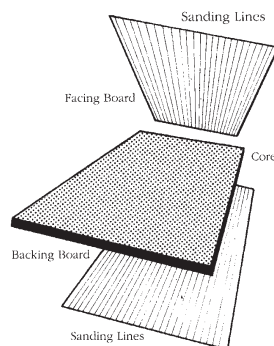

All composite panels must consist of a suitable substrate, a decorative face laminate and a suitable balancing laminate on the reverse of the panel. Suitable balancing laminates for various applications are detailed below.

## IMPORTANCE OF SHEET DIRECTION IN AVOIDING BOWING

1. Always use face and back laminate cut from the same direction of the laminate sheet and never at right angles to each other.
2. Whenever possible always cut the longest dimension of a panel from the 'L' direction of a sheet, i.e. with the sanding lines. This is because the dimensional movement in this direction is only half that of the 'T' direction.

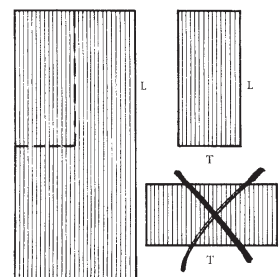

## RECOMMENDATIONS

Backing laminates should be selected from the following table according to flatness requirements.

Face Laminate	Category A Optimum flatness (Better than BS4965 limit)	Category B Flatness meeting BS4965 limit	Category C Sealing purposes only, flatness not guaranteed
HGS	Laminate identical to that of face laminate	HBS – Horizontal Standard Balancer	Any backing laminate e.g. Scarified backing board, Universal backing board, Production backing board, DC White etc.
VGS		VBS – Vertical Standard Balancer	
HGF		HBFS – Horizontal FR Balancer	
VFP		VBF – Vertical FR Balancer	
HGP		HBP – Horizontal PF Balancer	
ColorCore		ColorCore Scarified Balancer*	
PAR (ARPlus)		ARPlus Balancer	
DecoMetal Polished Chrome		M2016 Polished Chrome Balancer	
Other Polished Finishes		M2017 Polished Metallic Balancer	
Matt and Brushed		M2018 Matt Metallic Balancer	
Embossed Aluminium		M2055 Aluminium Embossed Balancer	Universal backing board
Embossed Copper		M2055 Aluminium Embossed Balancer	
Copper		M2019 Copper Balancer	
Stainless Steel	M2178 / M4767		

\*For ColorCore Multi-layering use Category A compensating laminate.

# SUBSTRATES (CORE BOARDS)

All laminates of thickness 2mm or less must be supported by a suitable substrate as detailed below.

The three purposes of a good substrate are:

1. To support the laminate
2. To resist bowing
3. To meet the required performance specification.

In addition, it is essential that the surface of the substrate should be sufficiently smooth to prevent the transfer of defects through to the decorative laminate surface (commonly known as telegraphing).

Plywood, chipboard and medium density fibreboard (MDF) are substrate materials which lend themselves to good fabrication.

Being cellulose based, their dimensional movement characteristics are similar to those of decorative laminates.

Certain industrial applications call for specialised substrates such as mineral boards, metal sheets, honeycomb cores and plastic foams and these will require special bonding and fabrication techniques.

The various substrates which may be used, together with their characteristics, are listed in the following table.

Substrate	Description and suitability
Particleboards. (chip)	<p>Thin boards are not self-supporting. Methods of attachment (eg framework) are dependent on the thickness of the composite board.</p> <p>The particleboard structure (chip form, resin content etc.) has a substantial influence on the surface quality and properties. Boards manufactured to type P3 of EN 312-3, Multi-layer boards, or those characterised by gradual chip structure transition, are most suitable for bonding to decorative laminates, boards must have been sanded uniformly on both sides to avoid subsequent shrinkage and distortion. To avoid any risk of delamination, the tensile strength perpendicular to the plane of the board, especially in fine surface layers, must meet all the minimum requirements specified by the National Standards. These boards can also be obtained in flame-retardant grades, conforming to fire performance of the Building Regulations and BS 476, parts 6/7, along with Euroclass (SBI) En 13823. Boards to type P5 of EN 312-5, having increased moisture resistance, can be used in installations subject to high humidity and frequent wetting. These may require special veneering/bonding techniques, refer to the board manufacturer for recommendations.</p>
Medium Density Fibreboard. (MDF)	<p>Thin boards (i.e. 6mm) are not self-supporting. MDF dry formed panels product manufactured from resin bonded lignocellulose fibres. Provides an excellent surface for laminating, and its excellent machining properties allow finely moulded and smooth edge finishes. Primarily used in furniture and cabinet work, where its properties are well suited to the need of these industries. Boards manufactured to type MDF of EN 622-5 are suitable for use in dry areas and can also be obtained in flame-retardant grades (class 0) boards manufactured to type MDF-H of EN 622-5 are moisture resistant and can be used in situations of high humidity and frequent wetting. Nominal density should exceed 560KG/m<sup>3</sup>.</p>
Laminboard and Blockboard	<p>These are self-supporting by virtue of their structure and thickness. Laminboard; i.e. those with narrow core strips, less than 12mm in width and edge glued, are excellent substrates for decorative laminates for cabinetry and high class work. Blockboard; only suitable as substrates for decorative laminates if their core staves are fairly narrow and edge glued with double or extra thick surface veneers. Otherwise they are unsuitable because the core (staves) may shrink unevenly in dry warm conditions, resulting in surface undulations (telegraphing).</p>



Substrate	Description and suitability
Plywood	Thin boards are not self-supporting. Methods of attachment (eg framework) are dependent on thickness of the composite board. Plywoods (EN 313 and EN 636) in low density hardwood (eg gaboon, poplar, obeche) are particularly suitable for bonding with decorative laminate. Boards impregnated with FR agents may require special veneering requirements HPL manufacturer should be consulted.
Fibre Building Boards (hardboard)	These are not self-supporting and generally used as outer skins of sandwich panels, or as wall cladding panels with their edges restrained in extruded plastic or metal channels section. Their surfaces may have to be sanded before bonding to improve adhesion. Nominal density of not less than 800kg/m <sup>3</sup> .
Honeycomb materials  e.g.	These are suitable when used as the central component of a composite core or in conjunction with a framework. Aluminium; ideal for producing rigid, lightweight panels faced on both sides with decorative laminates. Widely used in the manufacturing of curved ceiling panels, railway coaches. Usually bonded with Epoxy resin adhesive, and available in a variety of thicknesses and cell sizes. <i>Kraft Paper – non impregnated</i> ; Generally used as low-cost cores for sandwich panels faced with hardboard, or for plywood-faced hollow interior doors. Also used for direct laminating with HGS grades of laminates. For fixtures in caravans where low weight considerations are more important than impact resistance. Cell sizes are typically 15-30mm in a variety of thicknesses. <i>Kraft Paper – Impregnated</i> ; Resin impregnated paper is better than none-impregnated paper in resisting the effects of moisture, used generally in small cell sizes (e.g. 9-12mm) and thicknesses of 15 to 25mm.
Rigid foam materials	Rigid foams made from synthetic resins (e.g. polystyrene, PVC, phenolic, polyurethane) are suitable for bonding to decorative laminate. They have special thermal insulation properties and are suitable and self-supporting for vertical surfaces. They are also suitable as a central component enclosed in a timber frame. They have special thermal insulation properties, Phenolic foams have fire-retardant properties and low smoke emission.
Sheet Metal	Suitable after careful preliminary treatment. Aluminium and steel can provide excellent substrates providing the proper surface preparation is carried out prior to bonding. Metals have different dimensional movement characteristics to those of decorative laminates and this must be taken into account in considering the end application. BLFA technical information No 9
Mineral boards	A number of different non-combustible substrates are available, the most common being boards based on "Calcium Silicate". Decorative laminates should only be used on boards of monolithic structure and not on those produced by layering methods, as the latter have poor resistance to delamination. Moisture content of both laminate and substrate must be controlled by proper storage (pre-conditioned) prior to bonding. BLFA; technical information No8.
Solid Wood	Solid wood is only suitable for small areas because of the high risk of distortion and surface undulations caused by irregular dimensional movement. Maximum thickness 10mm for pre-lipping.
NOTE;  Plastered or Cement (rendered wall surfaces)  Gypsum Board (paper faced)	The following materials are NOT recommended as substrates for the application of decorative laminates. With rare exceptions these are unsuitable for direct bonding because of surface irregularities, low internal bond strength and incompatible dimensional movement. The paper surface affords little restraint to the dimensional movement of decorative laminates, and can lead to delamination (blistering) along with stress cracking from screw holes and apertures.

# ADHESIVES

	Urea/Melamine Urea	Resorcinol	Epoxy	Polyvinyl Acetate (PVAc)	Contact Adhesives	Hot Melt Adhesives
Description	Rigid thermosetting adhesives. Curing is by polymerization when the correct amount of catalyst is added to the resin. The rate of cure is rapidly increased by the application of heat.					
Application	Used in flat lamination, hot or cold pressed to bond laminates to wood based substrates. Melamine/Urea is useful for bonding to moisture resistant core materials. Poor gap filling properties but gives a good bond at relatively low pressures. Ureas are often extended by fillers which also help to reduce telegraphing of core imperfections. Cure time typically 1 to 3 hours at room temperature depending on hardener system.	Used in flat lamination, hot or cold pressed to bond laminates to moisture resistant wood-based substrates and non-combustible substrates Good gap filling properties. Satisfactory bonds are produced at low pressure. Cure time typically 5-8 hours at room temperature.	Used in flat lamination, hot or cold pressed to bond laminates to metal substrates which have first been primed. Also useful for bonding laminates to aluminium honeycomb cores. Excellent gap filling properties. Requires only low pressure. Minimal telegraphing due to high solids content (lack of shrinkage). Wide range of room temperature cure times depending on hardener system.	Used in flat lamination, hot or, more usually, cold pressed to bond laminates to most wood-based substrates. Also used for producing postformed components. Poor gap filling properties. Fast curing at room temperature giving quick press turn round (20-40 minutes), with long pot life to glue mixes. Requires only low pressure. Glue-line cures to a semi-rigid condition. Substrate must have good surface uniformity and strength. Easy wash down of equipment and removal of glue spillage. Requires carefully controlled glue spread to avoid telegraphing due to water base causing raised grain, fibre and chip swell.	Used for both flat bonding and postforming. Can be used to bond laminates to a wide variety of substrates. Bond occurs when both coated surfaces are brought into contact. Requires only momentary but high uniform pressure. Can be applied by spray (hot or cold) or by hand application with serrated spreader. Useful for on-site work where the application of sustained pressure is not possible. Observance of correct application and drying time is very important. Should only be used in warm, dry conditions. Minimal telegraphing providing laminating pressure is not excessive and glue-line is kept free from debris.	Normally supplied in pellet or cartridge form.  Used almost exclusively for bonding edging materials. Best applied to edge prior to application of surface laminate. Will begin to soften under moderately elevated temperatures. Should not be used to edge materials for use near hot surfaces.
Typical Temperature Resistance	-20°C to +120°C.	-20°C to +150°C.	-20°C to +100°C.	Standard, -20°C to +80°C. Catalysed, -20°C to +120°C.	Standard, -20°C to +60°C. With hardener, -20°C to +100°C.	Standard, -10°C to +50°C.
Typical En 204 Durability Class	D3 - D4	D4	D3 - D4	D2 - D3	D1 - D2	D1

## Key to EN 204 durability classes in adhesives table.

- D1 Interior areas, where the temperature only occasionally exceeds 50°C for a short time and the moisture content of the wood is 15% maximum.
- D2 Interior areas, with occasional short term exposure to running or condensed water and/or to occasional high humidity provided the moisture content of the wood does not exceed 18%.
- D3 Interior areas, with frequent short-term exposure to running or condensed water and/or to heavy exposure to high humidity. Exterior areas not exposed to weather.
- D4 Interior areas with frequent long-term exposure to running or condensed water. Exterior areas exposed to weather.

## ADHESIVES

### Polyurethane (PU) Single & 2 Part Systems

Description	Single part MCPU (Moisture Curing Polyurethane) relies on water / moisture to set off the curing. Hot pressing accelerates the curing cycle. One of the substrates MUST be porous. Two part PU or PUR relies on mixing the resin and catalyst together to set off the curing cycle. Hot pressing accelerates the curing cycle (adhesive manufacturer's recommendation). Excellent for bonding non-porous materials.
Application	Used in flat bonding lamination. Hot or cold. Applied by hand or specialised automatic rollers (steel). Spray or hand spreader / brush.
Typical Temperature Resistance	Not affected by high / low temperatures -20°C + 120°C
Typical EN 204 Durability Class	High humidity and frequent wetting. Very good D3 - D4 rating. Frequent, short-term exposure to running water and exposure to extreme humid conditions. Single part = D2 - D3 rating. Two part = D3 - D4 rating

Key to EN 204 durability classes in adhesives table.

D1 Interior areas where the temperature only occasionally exceeds 50°C for a short time and the moisture content of the wood is 15% maximum.

D2 Interior areas with occasional short term exposure to running or condensed water and/or to occasional high humidity provided the moisture content of the wood does not exceed 18%.

D3 Interior areas with frequent short-term exposure to running or condensed water and/or to heavy exposure to high humidity. Exterior areas not exposed to weather.

D4 Interior areas with frequent long-term exposure to running or condensed water. Exterior areas exposed to weather.

# POSTFORMING

## GENERAL

The term 'postforming' is used to describe the bending process applied to specially developed grades of laminate which, whilst possessing all the well known properties of standard grade high pressure laminates, can also be formed into simple cylindrical concave or convex curves.

Curved surfaces with their absence of visible seams are often more aesthetically pleasing than sharp edges on internal and external angles, and will eliminate joints in which dirt and water can accumulate.

Thickness plays an important part in formability. In general, thin laminates are capable of being formed to tighter radii than thicker laminates; however for a given thickness, flame retardant postforming laminates are less formable than non-FR postforming laminates.

Unlike some postforming laminates which have a shelf-life, the formability of Formica® laminates does not deteriorate during long-term storage.

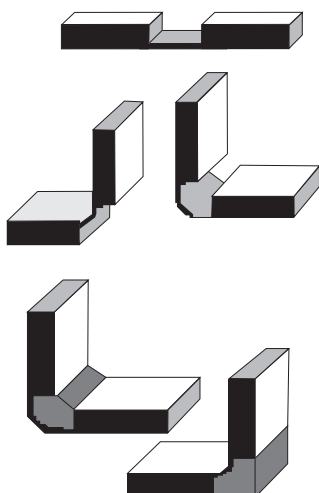

## POSTFORMED CORNERS

### Forming of modified Compact grade with machined groove (A)

In the area where the flat sheet is to be bent after manufacture, the laminate thickness is reduced to no greater than 0.7 to 0.9mm. By inserting a removable pre-shaped spacer or pre-formed jig, the laminate being of postforming grade is then formed using a static forming machine.

### Bending of modified Compact grade with Routed groove (B)

The compact sheet is manufactured flat in the normal manner, after which a groove is routed out, leaving a maximum thickness of 0.7mm to 0.8mm. The width of the groove is dependent upon the radius required. After bending over a pre-shaped jig / profile on the static machine the void is filled with high impact polyurethane resin.

## **POSTFORMING PROCESS**

All postforming processes require the laminate to be heated in the area in which it is to be formed, and the best (i.e. stress-free) bends are obtained when the laminate is heated to just below the temperature at which it will blister (approximately 190°C). Whilst the method of heating will vary, the forming temperature should be attained fairly rapidly.

Practically of course there must be a reasonably wide forming temperature zone (i.e. between the lowest temperature at which the laminate will form without cracking, and the highest temperature which can be safely used without the risk of blistering). The recommended forming temperature range for Formica® HGP and VGP postforming laminates is 163°C to 177°C. The recommended range for flame-retardant postforming grade VFP is 170°C to 180°C. White (light-coloured) laminates should always be formed at the upper end of the temperature range.

There are a number of postforming processes available, ranging from inexpensive workshop made jigs, to sophisticated machines processing panels on two edges at speeds of up to 15 metres per minute.

Whichever process is used however, the heating of the laminate must be meticulously controlled and monitored throughout the daily working period. Fluctuations in ambient temperature, heater voltage or machine speeds may upset critical heating conditions, resulting in cracking due to insufficient heat or blistering from too much heat.

The application of heat sensitive liquids or waxes to the area to be heated is a very effective way of checking the forming temperature. These liquids/waxes melt instantly at the prescribed temperature, giving an accurate visible indication when the laminate surface has reached the required temperature.

Hand-held infra-red thermometers can also be used, but care must be taken to ensure that the instrument is measuring only the temperature of the laminate surface and is not influenced by surrounding sources of heat or cold.

## **EQUIPMENT**

Most methods of postforming are based on the principle of first gluing the laminate to the flat area of the panel or worktop, which has been previously shaped on its edge to the required profile and forming and bonding the laminate simultaneously over the rounded edge. Whilst gluing processes differ, there are only two basic methods of postforming the laminate, stationary forming and continuous forming. In the former the workpiece remains static during the forming operation, whilst in the latter it is carried on a moving belt through the heating and forming zones of the machine.

## **STATIONARY OR STATIC FORMING**

In their basic forms, static forming machines are simple bending rigs. Essentially they consist of a flat stout bed to which the panel is pneumatically clamped with the overhanging laminate edge projecting. A retractable radiant heater descends and dwells over the laminate until the required forming temperature is reached, then the heater is retracted and an angled section folds the heated laminate over the edge profile and holds it in position until it is cool. An advantage of these machines is that they can be used for forming down-bends with large drop fronts.

Another process involves the replacement of the infra-red radiant heater by a narrow heated platen, which actually contacts the laminate surface and literally irons it around the prepared profile. Bonding takes place simultaneously with the forming process. Because this process is, in reality, a small mobile press it can use almost any type of adhesive. These machines are fully automatic and once set to a particular profile they will follow it repeatedly at the touch of a button.

### **CONTINUOUS FORMING**

Continuous forming machines vary considerably in their size and output capacity, but they all operate in a similar manner, in that the panel, which has had the edges radiused and the laminate bonded to the flat area, is carried by means of a chain or belt-drive through an infra-red heating zone, and past stainless steel bars which turn the now softened laminate over the profiled edge. Shaped rubber or metal rollers then take over and press the formed laminate edge in place until the adhesive is cured. Finally, the surplus laminate is trimmed off.

Continuous machines can be divided into two groups using different adhesive systems, i.e. PVAc and Contact Adhesives.

### **CONTINUOUS PROCESS USING PVAC ADHESIVES**

These machines are favoured in the mass production kitchen furniture industry because of the high degree of automation, and their ability to utilise adhesives which require no special extraction facilities and present no fire hazard. The panels or worktops are first veneered in a flat bonding press, with the laminate overhanging the profiled edges. The postforming machines are self contained units; forming, gluing and trimming in one pass.

### **CONTINUOUS PROCESS USING CONTACT ADHESIVES**

These machines are usually double sided and capable of considerable width adjustment. The panel or worktop is first veneered by spraying both the laminate and core-board (including the profiled edges) with neoprene adhesive, and bonding them under pressure by passing the assembly through rubber covered nip rollers.

During the postforming process the laminate is first heated by passing through an infra-red heating zone to reach forming temperature. The heat reactivates the adhesive so that when the laminate is formed and pressed home by the rollers, it will instantly bond with the adhesive coating on the profiled edges of the core-board.

### **COVING**

The internal (concave) bend of a worktop having an integral riser is usually achieved by milling away the core-board in the area of the bend, and then postforming the laminate over a heated metal former. An MDF in-fill piece (heel-piece) is inserted and glued in position after the laminate has been formed.

# SUBSTRATES FOR USE IN POSTFORMED COMPONENTS

The requirements for providing a good substrate for laminates in general fabrication apply also in postforming. In addition, a substrate having good edge machining properties (producing a smooth clean finish with minimum break out) is required to provide a smooth transition from the flat into the radius and flawless adhesion over the curve with minimum show-through.

## **CHIPBOARD**

Good quality chipboard having a smooth and even surface finish is essential. It should be constructed to prevent tearing out of the chip particles during the edge profiling process and provide a fine even surface with no voids. A brushing operation to remove loose particles after machining the profile is advisable.

## **MDF**

The excellent machining qualities of MDF make it an ideal substrate for producing smooth edge profiles.

## **PLYWOOD**

Machining of the profile is more difficult with plywood as the multiple glue lines can produce unequal wear of cutter blades.

Blades must be kept as sharp as possible and will benefit from being regularly cleaned and coated with a release agent to prevent resin build-up.

A post sanding operation followed by brushing is advisable after machining.

The machining direction should follow the grain of the surface veneers.

## **SOLID NOSE PIECES**

Where components are required to have a large internal or external radius, the profile should be fashioned from built-up sections of MDF or chipboard and never from solid timber, which may shrink and produce a ripple effect or telegraphing on the surface of the laminate.

# FORMICA® POSTFORMING PRODUCTS

The following table shows the recommended postforming conditions for Formica® laminates.

Where laminates are protective coated, trials should be made to ensure that the protective film does not soften and contaminate the equipment (particularly with continuous machines), and is removable after postforming. On request, grades HGP, VGP and VFP can be supplied with a high temperature film capable of withstanding temperatures up to 210°C.

Product	Forming temperature range	Minimum radius	Special conditions
HGP	163 - 177°C	White 12mm. Other colours 10mm	
VGP	163 – 177°C	White 12mm. Other colours 10mm	
VFP	170 – 180°C	15mm	
CPL	135-150°C	10 times nominal thickness	
DecoMetal®	120-135°C	12mm	Please refer to the Formica® Collection Availability Programme for details of post forming grade DecoMetal laminates.
AR Plus®	163-177°C	15mm-1.2mm/12mm-0.7mm	

For Postforming training courses contact our Fabrication Support Unit on [fsu@formica.com](mailto:fsu@formica.com) or through your local Formica Sales Office.



# MACHINING POSTFORMED COMPONENTS

## **CROSS CUTTING**

Single profile panels should be cut with the saw cut starting from and cutting into the profiled edge.

With panels profiled on both edges good cross cutting can only be obtained by the use of tungsten carbide tipped cross cutting saw blades with teeth as closely spaced as possible. The saw blade should be as thin as possible, not greater than 3.2mm kerf and every other tooth should be conically shaped, on triple chip configuration and having a 5° negative hook.

The traversing cross cut speed should be reduced. Better cuts are made when the panels are clamped stationary on the saw bed and the saw travels either over the panel (e.g. radial arm saw) or under the panel (e.g. beam saw).

Double profiled components, required to have perfectly clean cuts on both faces (e.g. doors), are best sawn by beam type saws having a contra-rotating scoring saw to nick the trailing profiled edge prior to the main cutting saw, to prevent break out.

## **CROSS PANEL MILLING**

Good quality edge cuts on panels profiled on both sides are obtained by the use of oscillating cutter heads working first against and then with the feed direction.

# CORNER JOINTING

## **MITRING**

Fully formed panels which have upstands can only be jointed by mitring, usually done by precise sawing. The panel is clamped at the required bisecting angle and a traversing saw, cutting into the face of the laminate, cuts through the panel.

It is essential that the panel is firmly clamped in position and the blade thickness is sufficient to prevent 'whip' causing break out of the laminate.

## **SCRIBED JOINTS (MASON'S MITRE)**

Single profiled edge panels can be jointed by machining suitable scribing profiles from the surface using a hand router with surface template. Panels over 40mm thickness should be machined using an overhead router.

## **PROFILE FILLETS**

Suitably shaped extruded metal or plastic profiles can be obtained which mask the joint, and these eliminate the need for precise machining.

## **JOINT ASSEMBLY**

The joints described in the previous paragraphs are usually clamped together using hand-rail type bolts sunk into the underside of the two panels. The joint is bonded with a moisture resistant adhesive.

# MACHINING

## GENERAL

Because decorative laminates have a relatively hard surface, tool wear will be greater than with most wood based products. For longer life and better performance tungsten carbide tipped (TCT) or polycrystalline (PCD) saws and cutters should be used.

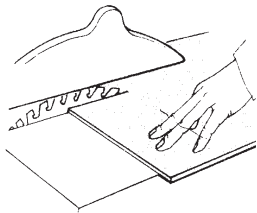

## CIRCULAR SAWS (FIXED)

The diameter of the saw blade should be as large as the machine will allow to give the highest available tip speed, but preferably not less than 150mm. For example, a 300mm diameter saw blade with a spindle speed of 3000 RPM will give a tip peripheral speed of 45m/s.

The sheet should be cut face up and held firmly down on the machine bed to prevent fluttering.

Generally, saws should be fine toothed and close pitched, with alternative teeth top bevelled. There are also a number of special saws now manufactured for cutting bonded and un-bonded laminates.

These include saws with the fronts of the teeth hollow ground and the tops bevelled on each side, and ground off or bossed saws. Both types will produce a clean cut on either side of a composite panel, the latter variety having the advantage of a thick centre for rigidity while giving a very fine cut.

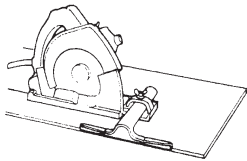

## CIRCULAR SAWS (PORTABLE)

Portable circular saws are particularly useful for on-site work. The direction of rotation of these saws requires the sheets to be cut face down to avoid chipping.

A fine toothed saw blade is essential to reduce the need for subsequent finishing

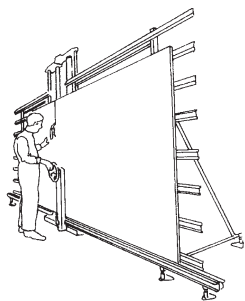

## WALL OR BEAM SAWS

The most convenient method of converting large sheets into smaller sizes is to clamp the sheet or sheets and pass a travelling saw across. These saws range from simple manually operated machines to the more sophisticated power operated clamped beam saws and wall mounted saws.

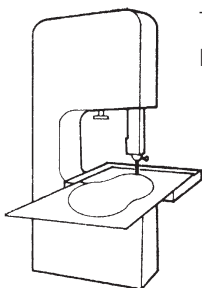

## BAND SAWS

The band saw is ideal for rough cutting of shaped work. Manganese steel blades having hacksaw shaped teeth are recommended

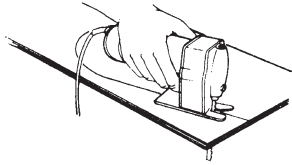

### **PORTABLE JIG SAWS**

These will produce cut-outs of any size or shape. Like the portable saw, the cutting action is upwards and therefore chip free cuts are difficult to achieve. Cuts should be made with a fine toothed blade and with the face side down. Where this is not possible due allowance should be made for the chipping that will occur.

### **SPINDLE MOULDER**

All normal cutting tools can be used in the machining of laminates but they must be tungsten carbide tipped. High speeds in the order of 5000-8000 RPM give the best results. Milling heads and cutter blocks with disposable TCT or PCD cutters (both straight and profiled) provide a convenient and relatively inexpensive method of machining the edges of boards. They also reduce down time for sharpening to a minimum.

Solid tipped cutter blocks with 4-10 blades, although expensive, soon pay for themselves in operations such as edge shooting, profiling and edge rebating of panels. Because they are precision ground, each cutting edge is utilised in the operation and wear is distributed over each blade. They can be used for a considerable time before re-sharpening is necessary and their weight gives them an inertia which minimises chatter.

When working laminates face down on the spindle table, it is advisable to clamp the workpiece to a moving pad to minimise the risk of scratching.

### **HIGH SPEED FIXED HEAD ROUTER**

Bench high speed fixed head routers may be used with single or double flute TCT cutters having an optimum peripheral speed of 10-15m/s.

Although primarily intended for cut-outs these machines can be used for a variety of operations such as profiling, edge trimming and grooving. It is not usually necessary for high speed routers to be used at speeds in excess of 18,000-20,000 RPM if only to avoid the very exact balancing requirements at speeds higher than these. For curved work it is advisable to rough cut the shape first on a band saw leaving 2-5mm all round for subsequent trimming on the router.

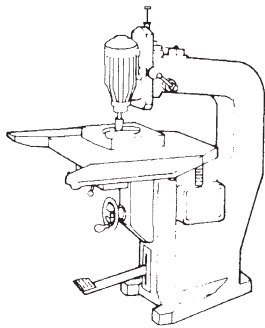

### **PORTABLE HAND ROUTERS**

Invaluable for clean hole cutting, edge finishing and trimming on site. Also very useful in the workshop for dealing with bulky assemblies. These routers can be fitted with small saws for on-site edge grooving of panels.

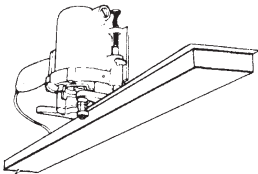

### **PORTABLE HAND TRIMMERS**

These compact hand electrical trimmers which operate at speeds of 18,000-20,000 RPM are designed principally for trimming decorative laminate. They are lightweight and easily operated with one hand. Depth of cut is usually controlled by an adjustable guide wheel, and TCT cutters are available for edge trimming at angles ranging from 50°-90°.

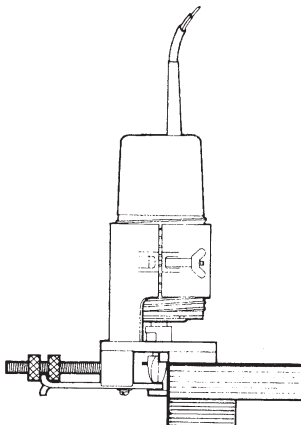

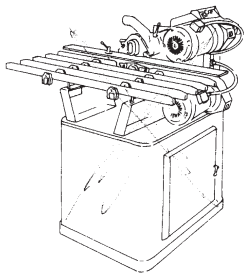

### EDGE TRIMMING

For volume edge trimming there are a number of sophisticated machines on the market. These machines will remove excess material from two edges and bevel one or both edges, all in one operation.

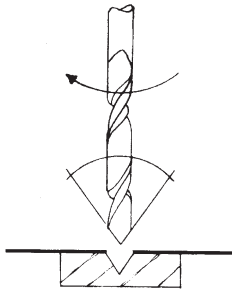

### DRILLING AND HOLE CUTTING

HSS steep spiral drills with a point angle of 60°-80° instead of the normal 120° are most suitable for small diameter holes.

Hole saws, cylinder cutters, trepanning or fly cutters, with a centre locating point are suitable for larger holes, which are best cut from both sides.

### C.N.C ROUTER

As with core materials surfaced on both and single sides decorative laminate sheets can be successfully machined on all four edges along with rebating or grooving using conventional tooling, (i.e. TCT, PCD.) The cutter head RPM and feed speeds are governed by the edge profiles and density of the sheet materials.

## HAND TOOLS

### CUTTING

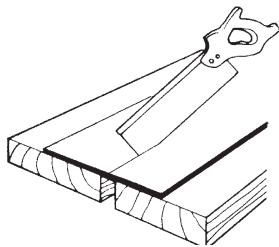

Laminates should be cut with a sharp, fine-toothed tenon or dovetail saw held at a low angle. The sheet should be supported on both sides of the cut as close as possible and over the entire length.

If the saw is not sharp excessive pressure will have to be applied to make a cut and this could result in the sheet splitting.

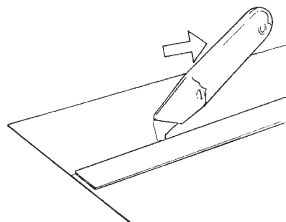

Alternatively, a craft knife with a laminate scoring blade developed specially for the purpose, a hooked scribe or the corner of a chisel can be used. The sheet should be laid flat on a firm base, decorative side up. It should then be scored with the scoring tool held against a thin straight edge using firm pressure, and taking care not to scratch the decorative surface. This operation is repeated until the decorative surface is cut through revealing the dark brown core. The sheet should then be broken upwards against the edge of a rigid straight edge.

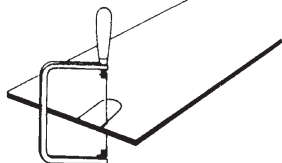

Scribing round mouldings, pipes etc. should be done with a coping saw.

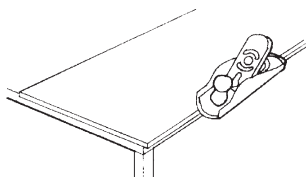

### PLANING

Trimming off surplus edges is best done with a small block plane with a low angle blade e.g. 60½ which is more easily controlled with one hand than a smoothing plane.

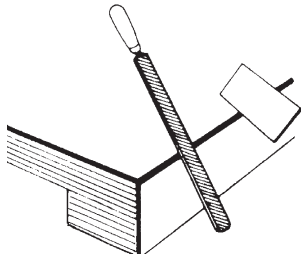

## HAND FINISHING

Final finishing of edges should be with a fine mill file and a cabinet maker's scraper.

## SAWING

Laminate should be sawn with a sharp, fine-toothed keyhole or joiner's saw held at a shallow angle. Sheets must be supported on both sides as close as possible to the cut, and along the whole of their length.

Saws must be sharp otherwise the sheet can crack because the cutting pressure is too high.

Cutting round mouldings, pipes etc. should be done with a coping saw.

## TRIMMING

Excess material from the edges is removed using a small mitre cutter with the blade at a shallow angle, which is easier to use with only one hand than a smoothing plane.

## HAND FINISHING

Finishing of the edges should be done with a fine mill file and a cabinet maker's scraper.

# EDGING

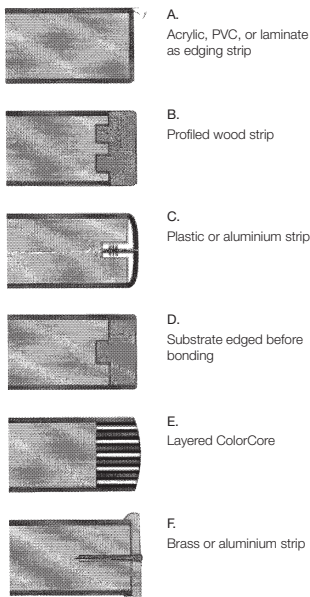

There is a series of edging processes apart from postforming that are suitable for both functional and purely aesthetic reasons.

Finished edge strips are certainly possible, but should not be regarded as compulsory because edging is strongly affected by production methods and design conditions.

## EDGING DETAILS

Edges on, e.g., table-tops, cabinet doors, and screen walls can be done in various ways. Here are a few examples of good edging techniques.

# APPLICATION DESIGN CONSIDERATIONS

The inherent characteristics of decorative laminates impose certain design restrictions. Some of these are outlined below. If you have any question concerning design and application please contact our Fabrication Support Unit (FSU).

## **SHEET SIZES**

Formica® decorative laminates are produced in a variety of sheet sizes, but not all grades/patterns/colours are available in all sizes.

When selecting a laminate please check availability of sheet size.

Due consideration should be given to specifying the most economical sheet size in order to minimise material wastage during cutting.

## **DESIGN FEATURES**

Sheets with geometric or linear features may need a dressing cut to properly align and position the feature relative to the edge of the panel.

## **DIMENSIONAL MOVEMENT**

High-pressure decorative laminates are cellulose-based materials and therefore, like any wood-based materials, they shrink in dry conditions and expand in wet conditions. Precautions should therefore be taken to prevent cracking or adhesive bond failure due to dimensional movement.

# SURFACE FINISH

## **GENERAL**

Formica decorative laminates are available in a variety of different surface textures and finishes. Some of these are available over a number of ranges, whilst others are integral to particular designs and patterns.

Choice of surface finish is important from a functional as well as an aesthetic point of view. In general, textured surfaces and light colours have a better scuff and scratch resistance than plane surfaces and dark colours. For this reason, glossy laminates and dark plain colours are not recommended for heavy duty working surfaces. On the other hand, plane and lightly textured surfaces are more easily cleaned than deeply textured finishes.

## **DecoMetal®**

Polished aluminium items have anodised surfaces for improved resistance to oxidation, scratches, staining, etc.

Other aluminium items have an epoxy coating, and copper finishes are protected with polyurethane lacquer.

Under certain fluorescent lighting conditions the polished finishes may show an iridescent effect.

# STRESS CRACKING

In conditions of low humidity caused by central heating, or of localised heating by radiator grilles or hot air vents, shrinkage may occur which can result in cracks from high stress points such as sharp internal corners or chipped edges.

Stress cracking is the result of stresses set up when the dimensional movements of the laminate and of the substrate to which it is bonded are different in either rate or direction.

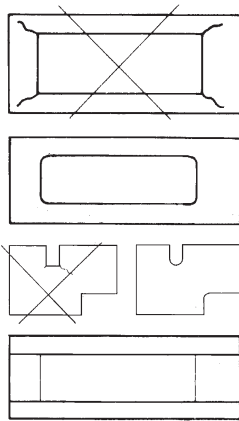

Stress cracking occurs most often when contact adhesives are used, as these adhesives are elastomeric (i.e. non-rigid) and allow the laminate to creep. To reduce the risk of stress cracking, the following measures should be followed:

1. Internal corners of apertures and cut-outs must always be smoothly radiused to as large a radius as possible. The minimum radius is 5mm, but this should be increased for apertures with large side lengths.
2. If sharp internal corners are required as a design feature, these should be formed by butt-jointing panels, and not by right-angled cut-outs.
3. All cut edges should be smooth, with no chipping.
4. The use of contact adhesives should be avoided, particularly where the ambient conditions in the final installation are warm and dry.
5. Where contact adhesive is used (particularly when hand applied), panel widths should not exceed 600mm. Where wider panel widths are required, these must be fabricated using rigid or semi-rigid adhesives.
6. In order to minimise dimensional movement, the longest dimension of the panel should be cut in the length direction of the laminate sheet, i.e. parallel with the sanding lines as laminate movement is approximately twice as great across the sheet width as it is along the length.
7. The laminate should be pre-conditioned in temperature/humidity conditions similar to those of the final installation for at least three days prior to bonding. This is particularly important if the laminate has a high moisture content following storage or transport in high humidity conditions.
8. Drilled holes for fixing screws etc. should be oversized to ensure that fixings do not impinge on the edge of the laminate.
9. The panels should be fixed firmly to prevent any bending or twisting which may cause stress.

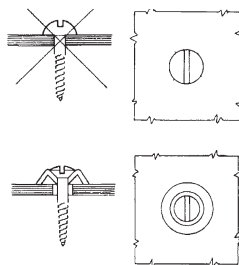



# ADHESIVE BOND FAILURE (BUBBLING)

Adhesive bond failure, commonly known as bubbling, may occur in conditions of high humidity or wetting if there are weak areas of adhesive bond (usually associated with hand-applied contact adhesives).

If the laminate has been bonded in normal dry conditions using contact adhesive and the panel is subsequently subjected to high levels of humidity, the laminate will expand. The amount of creep will depend on the panel dimensions (the larger the panel the greater the movement), and if there is a weakness in the bond the laminate may lift from the substrate.

To reduce the risk of bond failure, the following measures should be taken:

1. If possible, avoid the use of contact adhesives (particularly hand-applied) if the panels are to be installed in wet areas or areas of high humidity.
2. If contact adhesives must be used then panel widths should not exceed 600 mm. The adhesive layer must not be too thick, it must be applied evenly to both surfaces and the whole area must be at the correct tack-level when bonding takes place. These points are particularly important if the edges of the laminate are 'captured', preventing outward movement of the laminate at the edges.
3. To minimise dimensional movement, the longest dimension of the panel should be cut in the length direction of the laminate sheet, i.e. parallel with the sanding lines (laminare movement is approximately twice as great across the sheet width as it is along the length).
4. The laminate should be pre-conditioned in temperature/humidity conditions similar to those of the final installation for at least three days prior to bonding.

# FIXING AND JOINTING COMPOSITE BOARDS

Composite panels consisting of high pressure decorative laminates, adhesives, substrates and balancing laminates can be manufactured to achieve various performance requirements, including heavy duty, high humidity and defined fire performance. Composites are particularly suitable for wall cladding and may be used in a variety of situations.

## PREPARING THE WALL

In most cases it will be necessary to fit out the entire wall surface with a groundwork of horizontal timber battens. This groundwork should be of prepared timber with a minimum thickness of 22mm and a maximum distance between centres of 500mm. The battens should be erected true and plumb with vertical grounds at internal and external corners. In certain circumstances it may be necessary to use a framework of metal angles or channels instead of timber grounds.

## JOINTING AND FIXING

Close butt joints, without cover strips or surround, provide a clean, uniform surface.

But where joints occur it is good practice to bevel each panel slightly, so that a fine 'V' joint is obtained. Alternatively, feature joints may be created by spacing apart the edges of the boards, or by the introduction of an aluminium extrusion or matching or contrasting laminate strip.

For ease of installation and to reduce dimensional movement it is recommended that panel widths should be in order of 600mm, wider panels should be evenly supported with mounting brackets across the width.

The example shows typical basic good practice and is suitable for fixing composite boards. There are many other fixing methods based on this theme; the choice of a particular method, or combination of methods, is usually dictated by:

1. Substrate materials
2. Type of installation
3. Performance requirements
4. Design criteria

## TYPICAL GROUNDING DETAIL

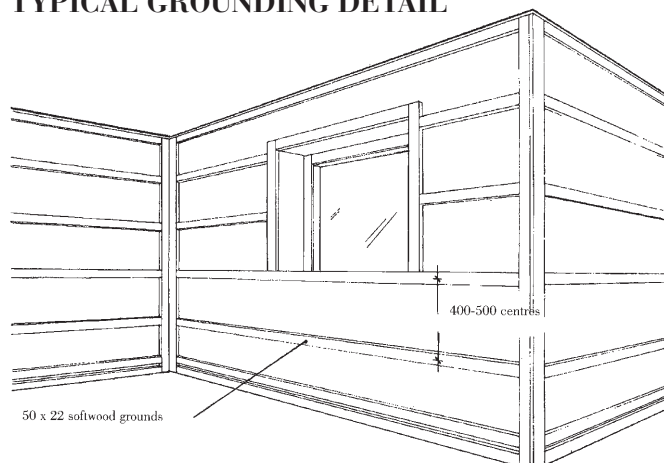

## JOINTING AND FIXING (CONTINUED)

Panels may be attached to the prepared grounds by plywood buttons or metal clips, by fixing through the joint detail, or by a combination of both. Where plywood buttons/metal clips are used, the grounds will need to be machined to suit prior to fixing.

Where the panel thickness permits, the edges may simply be grooved and a loose tongue or spline of hardboard or plywood inserted to align the panel faces, with each alternate edge pinned through the tongue. This method should not be relied upon as the sole means of supporting the panel.

Internal and external corners may be finished either square edged, or for a softer appearance postformed corners may be considered.

## PANEL ATTACHMENT DETAILS

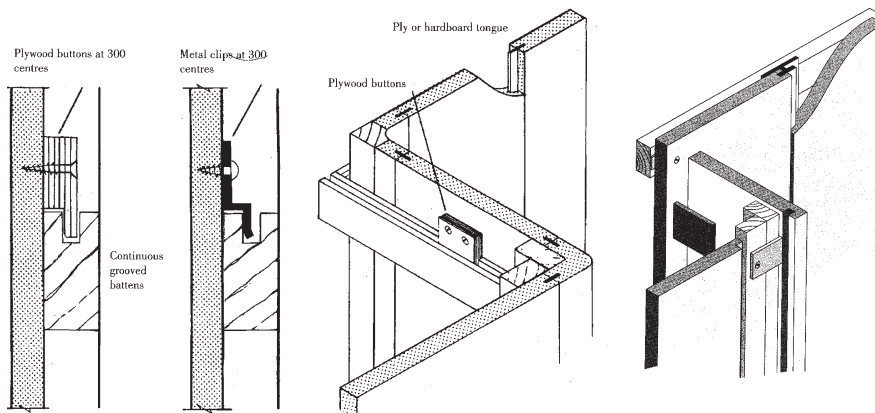

Panels with grooved edges may also be fixed with concealed extruded aluminium sections. This method requires the centres of the panels to be secured with constructional neoprene adhesive pads.

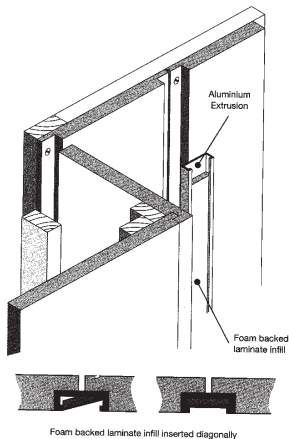

Where aluminium channel is used, the panel edges are rebated and fixed to prepared grounds using a temporary spacer to correctly position the joints. The aluminium channel is then screwed into the prepared space and filled with a foam backed laminate insert cut accurately to the internal dimension.

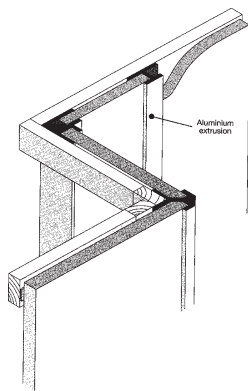

For soft-cored boards such as calcium silicate, it is recommended that the edges are captured by aluminium extrusions.

Ceiling and skirting details will be dictated by prevailing circumstances and design considerations; two examples are shown.

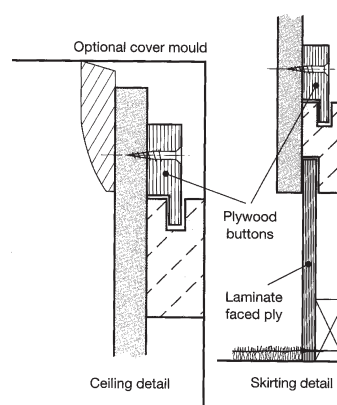

# DOOR CLADDING

With its attractive, easy to clean surface and resistance to abrasion, scuffing and indentation from day to day knocks, Formica® laminate provides an excellent, durable and low maintenance cladding material for doors in industrial, commercial and domestic installations.

This is especially applicable in hospital and laboratory areas where a hygienic, cleanable surface with a minimum of seams and crevices (offering minimal harbour for germs) is desirable.

## LAMINATE GRADE

Whilst doors by definition are vertical surfaces the necessity for good impact resistance is best satisfied by the use of Horizontal Standard Grade (HGS) laminate.

(Flame Retardant grade laminates are usually unnecessary even on Fire Resistant doors.)

## TYPES OF DOORS

Typically, there are two types of doors suitable for cladding with Formica laminate.

### HOLLOW DOORS

A typical construction consists of a frame of softwood members 33-44mm wide x 25-29mm thick, with a paper card honeycomb infill of the same thickness and a cell size of approximately 55mm.

No other timber members are used except for short pieces fixed to those inside members where mortice locks are to be fitted, and for framing around apertures.

4.5mm skins of plywood are glued to either side of this construction with thermosetting resin adhesive.

Formica laminate is applied in a subsequent pressing operation with a thermosetting adhesive

Hollow core doors provide neither fire nor acoustic insulation.

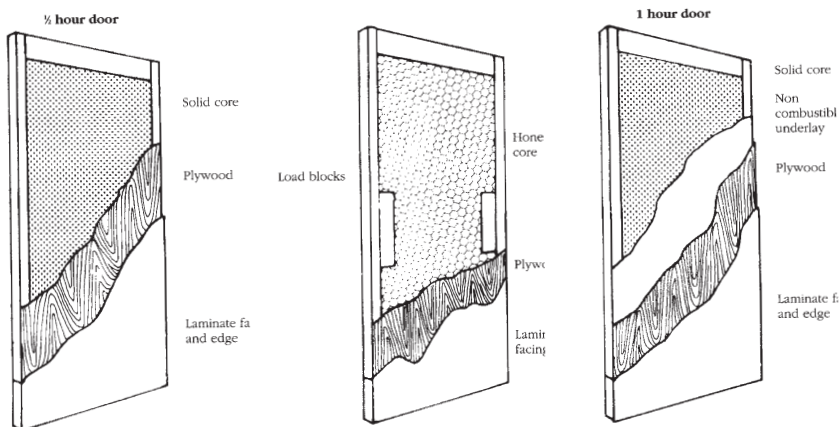

## SOLID CORE DOORS

These consist of infills of cork, flaxboard or chipboard (or alternatively glued stave and block construction) framed all round with glued timber members, and sanded flush.

3-4mm plywood is glued to either side of this core with thermosetting resin adhesive.

Formica® laminate is applied in a subsequent pressing operation using thermosetting adhesive. Solid doors can be used to provide both acoustic and thermal insulation and certain constructions can provide FD30 or FD60 fire resistance.

N.B. The type of door construction where the surface skins are supported only by vertical or horizontal members spaced at intervals (referred to as a Semi Solid Door) is not recommended for surfacing with Formica laminate because of possible show through of the framework.

## ADHESIVES

The adhesives used throughout should be thermosetting grades in accordance with EN 204, D3-D4 rating.

Fire resistant doors may require higher performance adhesives (ie. D4 rating) to achieve the integrity for the prescribed period.

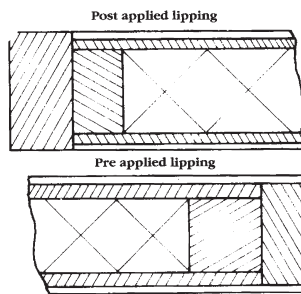

## LIPPINGS

Solid hardwood lippings 6-10mm thick are often glued to the edges of doors (using thermosetting adhesives) to provide an attractive and durable finish.

They can be applied either before the application of the laminate (pre-lipping) or in a subsequent operation (post-lipping).

## GLAZING APERTURES

Where openings are cut into either solid or hollow core doors the internal corners must always be smoothly radiused to a minimum of 5mm and glazing beads shaped accordingly.

# EXTERIOR USE (STANDARD)

Vivix® is a special range of exterior grade laminate offered specifically for use in rainscreen façade cladding and other external building elements. Please contact your local Formica Group sales office for more information.

Standard (interior) Formica laminates are not recommended for exterior use because of possible colour fade and whitening of the melamine surface which can occur through exposure to the UV radiation present in sunlight.

# FORMICA® LAMINATE USED AS A WRITING SURFACE (DRYWIPE BOARD)

Formica® Gloss white laminates (excluding AR Plus) are manufactured in accordance with EN 438:2005. And for all they are not specifically designed for use as a wipe board, the physical characteristics and surface finish provides a suitable writing surface for use with dry-marker pens, or felt tipped pens with water-soluble inks.

As there are a number of different marker pens in the market and certain ones, due to the solution composition, may have a tendency to leave what is termed as "ghosting" on the surface, in this instance point 3 from the following recommendations should be adopted.

## **SURFACE PREPARATION**

Prior to the Formica gloss laminate (wipe board) being commissioned, it is recommended that the laminate surface be cleaned throughout with acetone/denatured alcohol to remove any residues of adhesive from the protective polycoating.

## **DAILY CARE AND MAINTENANCE**

Some general steps to maintaining your wipe board surface.

1. From the initial cleaning, (surface preparation) wipe your board with a clean cloth moistened by a liquid cleaner.
  - Rinse with clean water. This step is simple but very important.
  - Wipe dry with a clean cloth.
2. Dry Erasing; using a drywipe eraser or drywipe cloth, recommended to be used at all times.
3. Surface Conditioning; using a spray or wet-wipe in conjunction with a clean drywipe cloth. Recommended to be used on a daily basis — leaving surface to dry afterwards for at least five minutes. More thorough cleaning may be required if writing is left on the board for more than two days.
4. Surface Restoration; recommended every 20-25 times a board is used (once a month on average), use a drywipe board restorer to remove all inks, dirt and grime, so that the surface will act like new.

The above information or suggestions are guidelines only, for more detailed information regarding the use of marker pens contact the pen manufacturer.

N.B. AR Plus is not recommended for drywipe board use.

# SPECIAL PRODUCTS - FORMICA® COMPACT GRADE LAMINATE

Compact grades are decorative laminates with a thickness of at least 2 mm and generally have a decorative surface on both sides. Being of homogeneous construction, they offer excellent dimensional stability and mechanical strength. Whilst laminate below 4 mm thick usually requires some measure of support (e.g. a metal frame), thicker laminates can be regarded as self supporting. Laminates over 8 mm thick are suitable for horizontal applications with the minimum of support. Not only do they meet all the requirements of EN 438:2005, ISO 4586 and the highest performance levels specified in BS 4965, they also possess high impact and moisture resistant properties.

Compact laminates are available in both standard and flame-retardant grades.

## **TRANSPORT**

During transport it is essential to use pallets of sufficient size to support the whole of the sheet area. Pallets must be strong and stable enough to support their load without bending or buckling.

The surface of each board must be free from debris, grit or foreign bodies, as they can become embedded under the weight of the stack resulting in damage to the surface.

When loading and unloading, boards must not be pushed or dragged over one another, but lifted cleanly by hand or suction device.

Stacked boards must be made secure against slipping.

## **STORAGE**

Compact sheets should be stored in enclosed warehouses where normal interior conditions (18-25°C and 50-60% relative humidity) are maintained.

Compact laminates will remain flat if stored horizontally in packs on a flat base board, with their edges flush with one another.

The base board must be dry and ideally it should be covered with a material impervious to water, to act as a moisture barrier.

The top sheet of each stack should also be covered with a moisture barrier/cover board, with sufficient weight to remain flat and in contact with the whole surface area of the top sheet of Compact.

This procedure should be maintained throughout their storage (whether in a warehouse or on the fabrication shop floor) and reinstated whenever a sheet is removed from the stack.

If Compact sheets are not stored flat for any length of time, deformation can result which will be almost impossible to rectify, particularly with thicker boards.

Protective films must be removed from both sides simultaneously.

## **FABRICATION**

All the general recommendations for the fabrication of thin laminates also apply to Compact laminates and they should be treated in the same manner as double sided composite boards. The following additional recommendations should also be observed.

## **GENERAL**

The increased thickness of Compact laminates imposes greater demands on cutting tools and causes greater wear. Slower feed-speeds than those generally used for cutting HPL-faced composite boards are required. The degree of feed-speed reduction will depend on the thickness of the laminate and the quality of finish required. Tool manufacturers should be consulted as to the type and quality of tungsten carbide tipping to provide the best performance. Where long production runs are contemplated and where a high quality finish is required, it is worth considering PCD (Polycrystalline Diamond) tooling. In all machine processes, localised heating caused by poorly maintained saws and cutters must be avoided. For optimum flatness the longest dimension of the panel should always be cut to coincide with the longest dimension of the Compact sheet.

## **SAWING**

Saw blades normally used for cutting double sided composites are generally suitable for cutting Compact grades. Saws of less than 2 mm in thickness are not recommended. Breakout on the underside of Compact sheets can be reduced by various methods.

1. By the use of a pre-scoring blade on the underside.
2. Using a base-board of plywood or hardboard beneath the Compact sheet.
3. Altering the exit angle of the saw blade by adjusting the height setting.

Note: The higher the saw blade the better the top cut and the worse the bottom cut and vice versa. The feed speed essentially governs the quality of the saw cut when sawing Compact laminates having two decorative faces. A speed of between 0.03 mm and 0.05 mm per saw tooth has been found to be the most successful.

## **PROFILE CUTTING AND EDGE FINISHING**

It is not necessary to apply edging strips or edge sealants to Compact panels and for many applications clean sawn edges are sufficient.

A spindle moulder or router may be used to achieve a superior finish or a profiled edge. For this type of work PCD tooling is recommended. Although it is not possible to achieve complete freedom from cutter marks, they can be minimised by feeding the work at a constant controlled speed by the use of a mechanical power feed. Care should be taken to avoid pausing during cutting and profiling, as burn marks may result which are difficult to remove. Where it is desirable for edges to be completely free from cutter marks, a further sanding and scraping operation is necessary. Edges may be further enhanced by buffing with steel wool and applying silicone-free oil.

Chamfering or profiling the edges of Compact panels will reduce the risk of edge impact damage.



## **DRILLING**

The most suitable drills for use on Compact laminates are those designed for plastic sheet materials. These drills have a point angle of 60°- 80° instead of the normal 120° for drilling metal.

To avoid breakout on the reverse side, the feed speed of the drilling head and the pressure applied should be gradually reduced approaching the point of breakthrough. Working on a firm underlay, such as plywood or chipboard, will also reduce the risk of breakout.

For blind boring into the face, the depth of the hole should be such that at least 1.5 mm of material remains between the bottom of the hole and the other side of the sheet. TCT lip and spur drills will produce clean flat bottomed blind holes, with less risk of point penetration on the reverse side. This will allow maximum depth of material to be used for fixings. Compact sheets less than 10mm thick are not considered suitable for blind fixing.

When drilling parallel to the surface (edge drilling) at least 3 mm of material must remain on either side of the hole. Threaded holes can be produced using engineers screw cutting taps. Self-tapping screws or threaded brass inserts may also be used.

## **INSTALLATION**

In the planning of any installation, it is essential to take into account the dimensional movement that can occur with Compact laminates and allowances must be made in the design, fabrication and installation processes. Movement in the length direction of the sheet is about half of that in the width direction. Typical dimensional movement values resulting from extreme change in relative humidity are as follows:

Transverse direction of the sheet: 2.5-3.0 mm per metre

Longitudinal direction of the sheet: 1.0-1.5 mm per metre

Compact panels used for wall cladding may be fixed by screwing directly through the face, or by hanging on a rigid supporting timber or metal framework with 'Z' clips. Thinner grades, 4-6 mm, may be bonded to a wood-based framework with heavy duty building adhesives. The chosen method of attachment will depend on the installation, board thickness and visual design criteria. In all applications the panels must be fixed to a rigid, secure system of horizontal supports at not more than 600 mm centres, with vertical support members at the joints appropriate to the detailing. Fixing clips should also be at maximum 600 mm centres. It is recommended that panels of less than full board width are used, both for ease of handling and reducing dimensional movement.

Compact panels should not be fixed to freshly constructed blockwork or brickwork until adequate drying has taken place, nor should they be fixed to damp external walls without the protection of a damp-proof membrane.

Adequate ventilation/air circulation must be provided behind the panels either by notching the support members or packing them off the wall. Typical minimum ventilation access at the top and bottom of the panels should be 20 cm<sup>2</sup> per square metre of panel area.

## **DIRECT FACE FIXING**

Through fixing holes should be at least 1.5 times the outside diameter of the screw being used and should be a minimum of 20 mm from the edge of the panel. Soft plastic bushes should be used to ensure correct centring of the screw in the hole, whilst still allowing for movement. Countersunk screws should not be used.

## **ATTACHING FIXING DEVICES**

'Z' clips and other secret fixing devices may be attached to the back of panels with 'Taptite' self-tapping screws or threaded brass expansion inserts. Screws and bolts with slow threads provide better resistance to working loose than those with fast threads. In all cases a blind pilot hole of the correct size must first be bored in the back of the panel. The depth of the hole should be at least 1 mm greater than the penetrating depth of the screw, and should leave at least 1.5 mm of material between the bottom of the hole and the face of the panel.

Rigid items, such as 'Z' clips and fixing angles, fixed to Compact panels, should have oversize holes to accommodate differential movement. A slip foil between the two components is also recommended. Expansion fasteners should not be used in edge-drilled holes (i.e. parallel to the surface).

## **EDGE TO EDGE JOINTING**

Edge-to-edge joints may be either tongued and grooved, or simply grooved and a loose spline inserted. Whichever method is chosen, the wall thickness of the groove should be greater than the width of the groove. The depth of the groove should be no greater than the thickness of the board and the length of the tongue/spline should be such as to accommodate the maximum anticipated movement. Compact laminates less than 8 mm thick are not suitable for edge grooving.

## **EDGE RETAINING PROFILES**

Edge retaining profiles of steel or aluminium should be used in situations where some movement of adjoining panels is anticipated, such as in vehicle construction.

## **POSTFORMED CORNERS**

Internal and external postformed Compact corners can be produced to a minimum radius of 15 mm and a maximum girth of 300 mm.

# COMPACT LAMINATES IN WET AREAS

Compact laminates are well suited to wet area applications such as shower cubicles, swimming pool lockers, etc. providing certain safeguards are observed. Formica® Compact Grade Laminate will withstand frequent wetting with hot or cold water and/or prolonged exposure to high humidity, but is not recommended for applications involving long term total immersion. Only standard grade Compact laminates (CGS) should be used in wet areas, as the hygroscopic nature of flame-retardant additives may give rise to surface blisters on Flame Retardant Compact laminates (CGF) if subjected to prolonged exposure to wet conditions.

In common with all high-pressure decorative laminates Compact laminates undergo a certain amount of dimensional movement when subjected to changes in humidity. In order to minimise the risk of bow occurring as a result of this movement, the following points should be observed:

1. In new buildings, or where excessive moisture conditions are present, it is recommended that, prior to fixing compact laminates, a process of pre-conditioning be carried out to ensure the sheets reach an equilibrium within the site conditions.

This can usually be achieved by laying the compact sheets on a pallet, neatly and flat, face to face and back to back, using carefully aligned spacer sticks (20 x 20mm) between the sheets at 300mm centres across the full area of the wallboards, in the area where they are to be used, (or in another area having identical conditions), for 7 to 10 days prior to installation.

2. Panels should be cut with the long edge parallel to the length of the sheet. Dimensional movement across the width of the sheet is twice as great as it is along the length, so cutting panels with the long dimension running across the width of the sheet will greatly increase the risk of bowing.
3. As far as possible, the ambient conditions should be the same on each side of the panel, as it is important that both sides gain or lose moisture at roughly the same rate. Where panels are mounted on a wall or enclose a vanity unit or Integrated Plumbing System (IPS), adequate ventilation must be provided to ensure that temperature and humidity conditions at the backs of the panels are essentially the same as those at the front.
4. Fixing centres should be sufficiently close to prevent excessive freedom of movement. Shower cubicle doors greater than 1500mm high should have three hinges.

# COLORCORE®

ColorCore® is a high quality surfacing material and, although most of the equipment and techniques used in the fabrication of normal laminates will apply, some additional techniques may be necessary to utilise the full potential of the product.

## **HANDLING AND STORAGE**

Because ColorCore is slightly more brittle than normal laminate it should be treated more carefully.

ColorCore should always be stored horizontally. Vertical storage is not recommended because of the risk of edge damage.

Boards should be stacked neatly, since projecting edges and corners are vulnerable to impact damage. If the sheet edges are accidentally damaged extra care should be exercised when lifting to prevent the sheet from tearing.

Storage conditions should be the same as those recommended for normal Formica® laminates.

## **CUTTING**

ColorCore can be cut using the same standard tools and equipment as used for other Formica decorative laminates. Cutters and saws should all be TCT and must be kept sharp to avoid chipping.

Because the slightly more brittle nature of ColorCore may result in chipping on the underside when cutting on circular saws, precautions should be taken to minimise the risk. Such precautions include: lowering the saw in the saw bench; reducing the throat of the saw by placing a piece of hardboard under the cut; changing the saw blade for one with negative angle teeth; or simply allowing an extra amount for edge trimming.

Large sheets may be cut by scoring but extra care must be taken to prevent shattering.

Cutting ColorCore on a laminate slitter is not recommended.

When cutting ColorCore by hand using a fine toothed saw, it should be well supported on both sides of the cut to prevent tearing.

## **BONDING AND PRESSING**

ColorCore may be hot or cold pressed and all the normal recommendations for bonding Formica laminates should be followed.

The most important point to remember is that the solid colour has no dark edge to mask the glue-line. Tight joints at right-angle intersections and the use of non-pigmented or transparent drying adhesives is essential to achieve a visually satisfactory end result.

## **SUBSTRATES**

ColorCore may be used with any substrate suitable for normal Formica decorative laminate.

## **ADHESIVES**

Although almost all normal laminate adhesives can be used to bond ColorCore, contact adhesives (particularly hand applied) are not recommended.

These flexible adhesives cannot properly restrain ColorCore, and this can lead to stress cracking and edge lifting unless special precautions are taken.

Since there is no dark edge to disguise the glue-line, the wrong choice of adhesive may result in the end product being visually unacceptable. Clear-drying PVA or UF adhesives give the best results, but will of course require sustained pressure.

If the use of contact adhesives is unavoidable then perimeter bonding, using a combination of adhesives, may be used to good effect. The technique involves bonding the main area of the panel with contact adhesive, and bonding a 25-30 mm perimeter strip with PVA or UF.

The edges should be cramped or taped down to produce a tight joint. This technique should also be employed around the edges of cut-outs.

The glue-line should be kept as thin and even as possible, consistent with achieving a sound bond. This is particularly important at the arrises, where a thick glue-line would spoil the desired monolithic effect.

Pigmented and dark coloured adhesives such as Resorcinol should be avoided, since the resulting coloured glue-line would be clearly visible in the finished product. If the use of dark coloured adhesives is unavoidable some modification to the normal bonding sequence may be necessary to enable the final piece of ColorCore to be bonded with a more suitable adhesive. For instance, hot-melt or neoprene could be used for pre-edging, and the main panel area bonded with PVA.

Post-applied edges will require more care in fabrication and choice of adhesive in order to produce an acceptable result. Hot-melt and contact adhesives should not be used for post-applied edging if a seamless joint effect is required. ColorCore laminates are offered in a limited colour palette only.

## **BACKING**

Where optimum flatness is required, use the same ColorCore laminate on both sides. Where a degree of bow can be tolerated (but within BS 4965 limits), or for panels that are fixed to a rigid substructure, use ColorCore Balancer.

## **BENDING**

ColorCore can be bent, but only to large radii because of its inherent stiffness. Strips 60 mm wide can be cold bent to a minimum radius of 150 mm, but the minimum radius will increase with increase in strip width. Heat will facilitate bending, but ColorCore is not postformable.

The solid seamless appearance for postformed components can be achieved by capping the ends in ColorCore.

Note: Due to the special characteristics of ColorCore, exact matches between ColorCore and Formica® Colors laminates may not always be possible. Formica Group recommend the comparison of actual laminate samples prior to specification or fabrication. Colorcore laminates are offered in a limited colour palette only.

## **MACHINING AND FINISHING**

All conventional tools and machines used for normal Formica® laminates can be used for fabricating ColorCore®, and all general recommendations relating to fabrication should be followed. To achieve aesthetically acceptable results the flushing off of the first piece of laminate to be applied, whether it is the edge or the main surface area, is critical. The overhanging ColorCore must be trimmed absolutely flush with the surface of the substrate, otherwise visible gaps will be evident at the arrises.

Arrises must be trimmed with hand trimmers in the usual manner, with either bevelled or small radius TCT cutters. For best results hand finishing with a fine file and a cabinet scraper is recommended. Generous bevels and radii up to 2.5 mm may be produced at the arrises, but it should be remembered that such large bevels and radii require more finishing to blend with the surrounding surface.

When filing or sanding the edges flush with the substrate, always work towards the substrate to prevent surface chipping. Sanding belts should be no coarser than 100 grit.

When trimming ColorCore down to the surface of normal laminate take extra care not to expose the brown core of the latter at the intersection.

## **SPECIAL EFFECTS**

The solid colour of ColorCore enables a wide variety of decorative effects to be achieved by techniques such as multi-layering, engraving, routing and sandblasting, or by combinations of any of these. The use of hardwood edges in conjunction with ColorCore can also create very interesting details. For further information on these techniques contact our Fabrication Support Unit (FSU) on [fsu@formica.com](mailto:fsu@formica.com).

## **MULTI-LAYERING**

Multi-coloured sandwiches of ColorCore can be bonded together and then sawn at 90° to the glue-line. These laminate strips can then be used for pre-lipping the edges of table tops, etc. for a solid laminated look.

Laminated work of this kind should be bonded with an epoxy adhesive and flat pressed. Prior to bonding, the decorative surfaces of the inner laminations must be thoroughly sanded to provide a good key for the adhesive.

## **ENGRAVING AND ROUTING**

The surface of ColorCore may be engraved or routed to a maximum depth of 0.8 mm. Interesting effects may be achieved by this method, ranging from straightforward sign-writing to intricate monochrome patterns and designs.

Designs in two or more colours can be achieved by a combination of multi-layering and routing. This technique entails bonding one colour on top of another and routing through to reveal the underlying colour or colours. Adhesives and bonding procedure should be the same as for multi-layering.

It should be remembered that cutting through the surface will release tension to some degree, and it may be necessary to machine the reverse side to maintain panel stability and prevent bowing.

A slight colour change may be noticeable in the machined areas due to differences in gloss levels, particularly with dark colours.

This difference in appearance can be minimised on narrow engraved lines by the application of a light silicone-free oil. Alternatively, large routed areas may be scraped and polished using progressively finer grades of glass paper, and a final buffing with a buffing paste.

## **SANDBLASTING**

Sandblasting is another technique that can be used to create interesting decorative effects with ColorCore, with surface texturing ranging from subtle changes in gloss level to deep sculpturing to a maximum depth of 0.8 mm.

## **FABRICATION GUIDELINES**

In order to produce a tight joint allow up to 6 mm overhang when applying the first piece of ColorCore to the edge of the substrate, for subsequent machining flush with the surface.

To avoid chipping, use sharp tools to machine ColorCore flush with the substrate. When sanding always work towards the substrate, using a fine grit sanding belt. Take care not to round-over the edge as this will result in a wide glue-line.

Apply the surface laminate with a thin (but sufficient) even coating of adhesive, again allowing a slight overhang. Use appropriate bonding pressure to achieve a tight glue-line.

Machine the finished edge of the surface laminate with a bevel or radius cutter, and file or scrape smooth.

# DECOMETAL®

DecoMetal® laminates are high pressure decorative laminates with metal surfaces. The range offers plain metals, patterns and textures in antique, classical and modern styles using real metal surfaces such as aluminium, copper, chrome and stainless steel.

The polished chrome surface is chrome plated onto copper.

Other polished effects have anodised aluminium surfaces and all other aluminium surfaces are coated with an epoxy lacquer to protect the aluminium foil. Copper surfaces are protected with a polyurethane lacquer.

## GENERAL CHARACTERISTICS

DecoMetal laminates are intended for use in vertical and light duty interior applications. They are not suitable for areas subject to wear and tear, such as horizontal working surfaces, or for long-term exposure to high humidity, wet conditions, or temperatures exceeding 60°C.

In some fluorescent lighting conditions DecoMetal laminates can display iridescent effects and panels should be viewed under actual lighting conditions prior to fixing.

During fabrication and installation always ensure that the sheets are all in the same running direction (as indicated on the protective coating), as variations in appearance can occur if sheets or panels are rotated through 90° or 180° in relation to each other.

Sheets with linear features may need a dressing cut to properly align and position the feature relative to the edge.

## HANDLING AND STORAGE

Sheets should be kept flat during storage and transport. They should not be rolled as this may induce a permanent bend in the laminate which will make subsequent fabrication more difficult. A protective coating is supplied on all sheets of DecoMetal laminates for protection during handling, fabrication and transport. It is recommended that the protective coating is left on the laminate until the finished product is installed and ready for use. Do not use adhesive tapes on the surface as they may damage the lacquer coating.

## FABRICATION

With the exception of Stainless Steel, DecoMetal laminates can be fabricated using the same techniques as for any Formica® laminate, however extra care is required to ensure good quality finished appearance.

## GENERAL MACHINING

With the exception of Stainless Steel, DecoMetal laminates can be machined using the same standard tools and equipment as used for other Formica laminates, but extra care should be taken to avoid damaging the surface.



## MACHINING STAINLESS STEEL

Stainless steel is a very hard metal and although the foil is only 50 to 100µm thick, it will still have an adverse effect on cutters and some reduction in cutter life should be expected. Heat generated by friction is the main problem and anything that reduces this will prolong cutter life.

Sawing stainless steel DecoMetal® will not present any special problems. TCT saw blades with a triple chip tooth profile will produce good results. Always cut with the face-side up, allowing 20-25 mm of blade projection above the surface of the board. Reducing the throat of the saw to the kerf width by the use of a carrier board will eliminate pulling and bending of the laminate. For double sided panels the use of a scoring saw is recommended.

Edge milling and trimming are the two operations where problems may be experienced. Most routers and laminate trimmers revolve at between 15,000 and 30,000 rpm which, at normal feed speeds, is too fast for stainless steel and causes friction generated heat that will quickly dull the cutter.

The solution to this problem is to reduce the cutter speed and/or increase the feed speed to achieve an acceptable finish with minimum cutter marks. Some experimentation may be required to achieve optimum results.

With variable speed equipment always start at the lower end of the rpm scale to avoid damage to the cutter during setting up. With fixed speed equipment always feed as fast as possible within the limits of the equipment. At 15,000-18,000 rpm a feed speed of 15 m/min. has been found to produce acceptable results.

Retract the cutter from the workpiece as soon as the cut is complete, and do not pause mid-cut, as dwelling at one spot will greatly reduce cutter life. Over-extending a dull cutter will result in excessive heat that may cause delamination of the stainless steel foil. Use small diameter cutters to reduce peripheral speed.

Edge milling of laminated panels on CNC routers is best carried out using solid carbide spiral cutters with either left or right hand twist. The choice will depend on whether the panel is face up (left-hand twist) or face down (right-hand twist).

Machines that have a relatively low rotational speed, but a high peripheral speed (such as spindle moulders) will inevitably produce a cutter chatter pattern if fed at high speed.

However, if an optimum balance between the most suitable machine speed and feed speed is established an acceptable finish can be achieved.

Edge trimming may be carried out with conventional equipment, i.e. fixed or portable routers, or hand laminate trimmers. If hand trimmers are used, the overhanging laminate should be kept to a minimum to enable the limited power of the machine to cope with faster feed speed.

Bevel trimming at 60° is preferred to 45° as this will minimise the width of cut through the stainless steel. Flush trimming at 90° will give the maximum cutter life, as vertical movement will produce a number of fresh cutting edges.

Any slight burrs or cutter marks may be removed with a fine file or abrasive paper, always cutting on the down stroke.

In order to achieve the best possible finish on stainless steel, all cutters used must be sharp and well maintained. Disposable TCT cutters are recommended wherever possible, for speed and ease of maintenance.

If self-guide cutters are used they should be of the ball bearing type and not fixed pin. Make sure all bearing guides are free running to avoid marking the surface.

**CAUTION: Burrs and metal edges are very sharp and can cut flesh and electric cables.**

## **SUBSTRATES AND ADHESIVES**

Due to the nature of the surface finishes (especially polished finish) only substrates with a high quality surface, free from undulations and imperfections, should be used.

Most adhesives can be used with the exception of those based on urea (i.e. UF and MUF types).

Adhesives must be evenly spread and free from inclusions to avoid surface distortion. With polished finishes, best results are achieved using adhesives with low shrinkage (e.g. PVA) to minimise telegraphing. Whilst good fabrication technique can minimise optical distortion, some surface ripple is inevitable and it is not possible to achieve a perfect mirror finish.

## **PRESSING**

DecoMetal® laminates should be press bonded to achieve optimum aesthetic appearance.

Press platens and nip rollers must be clean and any creases in the protective coating should be smoothed down prior to pressing.

Any glue spillage should be removed immediately with warm water and a damp cloth.

Cold or hot pressing (60°C maximum) can be used, at a pressure of 10-30 N/cm<sup>2</sup> (14-43 psi).

When pressing embossed laminates suitable padding should be used to obtain uniform pressure.

## **COUNTER VENEERING**

Do not use melamine surfaced decorative laminates to balance DecoMetal laminates.

For optimum flatness use the same laminate on both sides (Category A).

Flatness meeting BS 4965 requirements (1 mm maximum distortion over 600 mm length) can be achieved using the corresponding metallic balancer (Category B).

For small panels, or where flatness is less important, a phenolic laminate backing board may be used (Category C).

Pre-conditioning should be carried out as for normal laminates.

## **FINISHING**

Edges may be trimmed in the normal manner and any burrs can be removed with a fine file, always working towards the laminate surface. Corners of internal cut-outs must be radiused and free from chipping.

## **COLD BENDING**

As a general rule, DecoMetal laminate strips in widths of up to 60 mm can be cold bent to a radius of 200 mm. Although it is possible to cold bend wider strips considerable force is required and, in addition to adhesive, the laminate must be fixed back with a metal section or capping strip to prevent spring-back.

## **POSTFORMING**

Some DecoMetal® items are available in postforming quality, identified by the grade MTP in 'The Collection Availability Programme'. These laminates can be formed in the temperature range 120-130°C, using normal static or continuous postforming machines. The recommended minimum forming radius is 12mm, although tighter bends may be achievable depending on equipment and technique.

## **CARE AND MAINTENANCE**

DecoMetal laminates should be cleaned with warm soapy water or mild household detergent solution and a soft cloth. Abrasive cleaners must not be used. Solvent cleaners must be used with care and should be tried first on a scrap off-cut to ensure that no surface damage results. Solvents must not be used on products having polyurethane lacquer finishes.

# M5316 KORTEN

## USAGE

M5316 Korten is a melamine faced laminate incorporating iron particles. This gives the material some magnetic properties and its special decorative effect. The laminate is ideal for use in interior, vertical applications.

M5316 Korten is a hand-made design and each individual sheet is unique. Variations between sheets are characteristic of the design and manufacturing process.

## HANDLING AND STORAGE

M5316 Korten sheets should be stored in the same conditions as other DecoMetal® and standard Formica® laminates. M5316 Korten sheets should be stored flat and transported on suitable pallets.

Sheets should not be rolled or folded for transportation as this can cause irreversible damage to the sheets and they will be more difficult to fabricate. M5316 Korten is not offered with a protective poly coating, but has a paper sheet interleaving for protection during transportation.

Gloves should be worn when handling this laminate as the rough surface of the laminate can cause mild abrasions.

A cover board should be used during the storage process.

## FABRICATION

M5316 Korten sheets can be fabricated using similar techniques to all other Formica laminates; however certain recommendations should be followed to ensure a good finish.

TCT circular saw blades should be used with a minimum of 60 teeth per blade with a tooth thickness of 1.8mm. The diameter of the blade should be 305mm. Saw blades with a negative hook are also recommended.

Care should be taken when cutting the laminate sheets as sparks and flying chippings can occur. **Eye protection must be worn even when guards are in place!**

M5316 Korten sheets cannot be trimmed like conventional laminates as the cutters burn out very quickly due to the iron content of the laminate. For sizing it is recommended that the laminate is bonded to a substrate and cut to size. The sawn edge can be smoothed with a metal file to remove any burrs; however, this will highlight the deposits of iron on the surface. This is a characteristic of the material and cannot be considered as a fault.

If hand routers are used then the surface of the laminate must be protected to prevent surface damage which can be caused by small particles becoming trapped under the router bed. A cover board is recommended as scuff marks from router beds cannot be removed. The surface of the laminate can also damage the beds of the machinery due to the rough surface.

When cutting and trimming M5316 Korten, tooling will have a life span of approximately 1/3rd of that compared to cutting conventional laminates.

## SUBSTRATES

M5316 Korten boards can be bonded to the same substrates as conventional Formica laminates. Plywood, Chipboard and MDF are recommended.

## ADHESIVES

M5316 Korten sheets can be bonded with the same adhesives as conventional Formica laminates and other DecoMetal laminates. PVA or UF will give the best results but will need to be pressed under continuous pressure. Neoprene or Contact Adhesive, especially hand-applied, is not recommended.

Cold or hot pressing can be done; maximum temperature for hot pressing is 60°C. All adhesive spillage should be removed immediately with a damp cloth.

## BALANCING

Panels laminated with M5316 Korten should be balanced with the same laminate on the reverse. A minimum sheet thickness of 12mm is recommended as no guarantees of flatness can be given on sheets less than this thickness. If panel flatness is not essential, or the back of the panel is hidden, then lesser grade balancing laminates are available.

## NOTE

The above is intended as a guide only. It is recommended that tests be carried out and approved by the end user before any major fabrication is undertaken.

DecoMetal® product	Category A Optimum flatness	Category B Flatness within BS4965 limit	Category C For sealing purposes only
Polished Chrome	Laminate identical to that of face laminate	M2016 Polished Chrome Balancer	Universal backing board
Other Polished Finishes		M2017 Polished Metallic Balancer	
Matt and Brushed		M2018 Matt Metallic Balancer	
Embossed Aluminium		M2055 Aluminium Embossed Balancer	
Embossed Copper		M2055 Aluminium Embossed Balancer	
Copper		M2019 Copper Balancer	
Stainless Steel		M2178 / M4767	

# FORMICA® MAGNETIC LAMINATE

Formica® Magnetic Laminate is a decorative laminate with all the benefits and assured quality of traditional Formica laminate but with added advantages ideal for communication and display.

Carefully selected colours and a mix of surface finishes combine to offer a wide variety of applications and uses in environments such as retail, education, commercial and residential.

All achieve a very high magnetic effect and can be written on with chalks or special board markers, making them ideal for use in display, presentation and information boards. They can also provide the perfect backdrop for visual display projection.

Formica Magnetic Laminate is available in decors aligned to the Formica Colors and DecoMetal® ranges. Due to the special characteristics of this product, exact matches in colour or surface finish between magnetic range decors and Formica Colors and DecoMetal products may not always be possible. We recommend the comparison of actual samples before specification, fabrication or installation.

Due to manufacturing process, slight differences in gloss level from sheet to sheet might be evident and are unavoidable.

Sheets must be transported and stored flat to avoid damaging the surface.

Formica Magnetic Laminates incorporate iron foil and show a strong magnetic effect. Sparks can be emitted during processing.

Surfaces are protected by a removable film (except M4702). After the removal of the film and before using the product for the first time, thoroughly clean the surface with a conventional spirit (ethyl alcohol). Do not use detergents, such as washing up liquids.

Please note that some surface finishes have limited dry wipe capabilities and that frequent, intensive cleaning might be necessary.

It is recommended that users satisfy themselves as to the suitability of the product for its intended use.

## **USAGE**

Formica® Magnetic laminates are a high pressure decorative laminates, with an iron foil incorporated under the surface décor, and have a matt, gloss or brushed finish.

The iron foil gives the laminate its magnetic qualities.

Matt and gloss finishes are ideal for use as chalk boards or marker boards with the added benefit of magnetic properties. Brushed finish is suitable for use as display surfaces.

## **MATT FINISH**

Formica Magnetic Laminates in matt finish are especially suitable for use as chalkboard, or similar, surfaces in education, retail and commercial environments. Text and images can be drawn onto the surface using conventional classroom chalks and water-soluble liquid chalk pens.

Conventional classroom chalks can be removed using a soft cloth or a felt chalkboard eraser.

Some ghosting may be visible from the chalk left on the surface. This can be removed using a damp cloth. It is recommended that this cleaning process is done on a regular basis to help remove ghosting and chalk residues.

Water-soluble liquid chalk pens can also be used. These can be removed with a soft damp cloth.

Some ghosting can occur the longer the text or image is left on the surface of the laminate. This can be removed by using proprietary Whiteboard Cleaning Foam, or similar.

Even after cleaning the laminate several times, some ghosting may still be evident.

Micro Fibre cleaning cloths are also recommended.

## **GLOSS FINISH**

Formica Magnetic Laminates in gloss finish are especially suitable for use as marker boards or writing surfaces in education, office and commercial environments.

Text and images can be drawn onto the surface using good quality drywipe marker pens or water-soluble liquid chalk pens. This can be removed using a felt-based eraser.

Depending on the quality of the pens no ghosting should occur, however if ghosting does occur then this can be removed by using a proprietary Whiteboard Cleaning Foam, or similar.

Water-soluble pens can also be used and these can be removed by using water and a soft cloth.

Note: The longer the images or text is left on the surface, the more difficult they are to remove. Extra effort may be required to remove stubborn liquid chalk residue.

## **HANDLING AND STORAGE**

Formica® Magnetic Laminate should be stored in the same conditions as other DecoMetal® and Formica laminates. Formica Magnetic Laminate should be stored flat and transported on suitable pallets. It should not be rolled or folded for transportation as this can cause irreversible damage to the sheet and will be more difficult to fabricate.

## **FABRICATION**

Formica Magnetic Laminate can be fabricated using similar techniques to all other Formica laminate; however, certain recommendations should be followed to ensure a good finish.

TCT circular saw blades should be used with a minimum of 60 teeth per blade with a tooth thickness of 1.8mm. The diameter of the blade should be 305mm. Saw blades with a negative hook are also recommended. Care should be taken when cutting the magnetic laminate sheets as sparks and flying chippings can occur. **Eye protection must be worn even when guards are in place!**

Formica Magnetic laminate cannot be trimmed like conventional Formica laminates, as the cutters burn out very quickly due to the steel content of the laminate. For sizing, it is recommended that the laminate is bonded to a substrate and cut to size. The sawn edge can be smoothed with a metal file to remove any burrs.

## **SUBSTRATES**

Formica Magnetic Laminate can be bonded to the same substrates as conventional Formica laminate. Plywood, Chipboard and MDF are recommended.

## **ADHESIVES**

Formica Magnetic Laminate can be bonded with the same adhesives as conventional Formica laminate and other DecoMetal laminates. PVA or UF adhesive will give the best results, but bonding has to be done under continuous pressure.

Neoprene or Contact adhesive, especially hand-applied, is not recommended.

Cold or hot pressing can be done; maximum temperature for hot pressing is 60 deg C. All adhesive spillage should be removed immediately with a damp cloth.

## **BALANCING**

Panels laminated with Formica Magnetic Laminates should be balanced with the same magnetic laminate on the reverse. A minimum bonded sheet thickness of 12mm is recommended. No guarantees of flatness can be given on sheets less than this thickness.

If panel flatness is not essential, or the back of the panel is hidden, then lesser grade balancing laminates are available. Please contact Fabrication Support Unit, or Customer Service Department for further details.

## **NOTE**

The above is intended as a guide only. It is recommended that tests be carried out before any major fabrication is undertaken.



# FORMICA® DOUBLE SIDED MAGNETIC LAMINATE (M4702)

## USAGE

Formica® Double Sided Magnetic laminate (M4702) has a phenolic kraft core without a decorative face. It has two layers of phenolic kraft core with a mild steel foil (approx. 200 mic.) sandwiched in between. The steel foil in the middle of the laminate gives the sheet magnetic qualities. M4702 can be used to add magnetic properties to almost any laminate from the Formica® Collection. These can then be used for magnetic notice boards and magnetic dry wipe boards (please see special recommendations in the Formica Fabrication Guide before using as dry wipe boards).

Most laminates from the Formica Collection can be used, including Compact laminate.

Thicknesses of up to 4mm can be used without noticeable magnetic loss. Thicknesses of above 4mm will show loss of magnetic strength. As the thickness of the laminate increases, the strength of the magnetic effect decreases.

## HANDLING AND STORAGE

M4702 Double Sided Magnetic laminate should be stored in the same conditions as other Formica brand and DecoMetal® laminates. M4702 Double Sided Magnetic Laminate should be stored flat and transported on suitable pallets. It should not be rolled or folded for transportation as this can cause irreversible damage to the sheet and will be more difficult to fabricate. During storage it is important that a cover board is placed on top of the laminate to prevent curling.

## BONDING

M4702 Double Sided Magnetic laminate cannot be bonded using standard adhesives. We would recommend the use of Epoxy resin such as Araldite AY103-1 resin and HY991 hardener or similar. The materials will have to be press bonded when using this adhesive. Curing time will depend on the ratio of resin to hardener. Please refer to the adhesive manufacturer's specific instructions. Sprayable Neoprene adhesive can also be used but, due to the dimensional movement which can occur, we would recommend that this type of adhesive is used only for small applications. Panels should be no wider than 600mm when using contact adhesive.

When bonding gloss laminates to M4702 Double Sided Magnetic laminate it is important to ensure all surfaces are clean and free from debris. All platens of the press should be free from dirt as this could be pressed into the laminate surface and cause undulations. It is also important to ensure that no debris is between the decorative laminate and the M4702 laminate as this could result in telegraphing.

Formica Group accepts no responsibility for telegraphing or undulations caused during this process.

M4702 Double Sided Magnetic laminate can be bonded to all the usual substrates, such as MDF, Plywood or Chipboard.

## **FABRICATION**

M4702 Double Sided Magnetic laminate can be fabricated using similar techniques to those recommended for all other Formica® laminates, however certain, particular recommendations should be followed to ensure a good finish. TCT circular saw blades should be used with a minimum of 60 teeth per blade with a tooth thickness of 1.8mm. The diameter of the blade should be 305mm. Saw blades with a negative hook are also recommended.

Care should be taken when cutting the laminate sheets as sparks and flying chippings can occur. **Eye protection must be worn even when guards are in place!**

M4702 Double Sided Magnetic laminate cannot be trimmed like conventional laminates as the cutters burn out very quickly due to the steel content of the laminate. For sizing it is recommended that the laminate is bonded to a substrate and cut to size. The sawn edge can be smoothed with a metal file to remove any burs.

## **SUBSTRATES**

M4702 Double Sided Magnetic laminate can be bonded to the same substrates as conventional Formica laminates. Plywood, Chipboard and MDF are recommended.

## **BALANCING**

Panels laminated with M4702 Double Sided Magnetic laminate should be balanced with the same magnetic laminate on the reverse. A minimum sheet thickness of 12mm is recommended as no guarantees of flatness can be given on sheets less than this thickness. If panel flatness is not essential, or the back of the panel is hidden, then lesser grade balancing laminates are available. Please refer to the section in the Formica Fabrication Guide on balancing for the correct laminate to use.

## **NOTE**

The above is intended as a guide only. It is recommended that tests be carried out before any major fabrication is undertaken.

# SPECIFICATION CLAUSES

Specification clauses all follow a similar general pattern; but different applications and products each require different types of detail appropriate to the specification.

Where possible, use NBS Specification Clauses, ensuring that all details are complete. The following NBS clauses are relevant when specifying various Formica® products:

## K13 Rigid Sheet Fine Linings / Panelling

Clauses: 130, 140

## K32 Framed Panel Cubicle Partitions

Clauses: 10, 120

## L20 Doors / Shutters / Hatches

Clauses: 20, 230

## N10 General Fixtures / Furnishings / Equipment

Clauses: 350, 40

## N13 Sanitary Appliances / Fitting

The NBS web site ([www.nbsplus.co.uk](http://www.nbsplus.co.uk)) contains pro-formas for each of those clauses, ready to complete with your details.

Where no NBS clause exists, devise your own specification clause covering the essential details.

For help with writing a specification clause, contact your local Specification Advisor.

As a guide to completing specification clauses, see the example that follows.

### Panels

Fire rating:	BS 476: Surface spread of flame Class 2/1/0 Consult with Formica Group for Fire Ratings related to specific applications
Product / Manufacturer:	Formica Group
Board Type Ref:	BS 4965 D4. HG. F0
Thickness:	As board type
Moisture Content on Delivery:	As Formica Group recommendations
Configuration / Dimensions / Joint Details:	As Drawings Reference KB/46.12/09.01
Edge Treatment:	Square self-edged
Special Profiles:	As required
Face Laminate:	
Colour:	Polar White
Pattern Ref:	F2255
Range:	Formica® Colors
Surface Finish:	Matte 58
Grade:	HGP

For more information on products mentioned in this brochure  
please contact your local Formica Sales Office:

**Austria**

Tel: +49 (0) 180 367 64 22  
austria@formica.com

**Belgium**

Tel: +32 2 705 18 18  
contact.belgie@formica.com

**Denmark**

Tel: +45 43 58 82 00  
info.danmark@formica.com

**Finland**

Tel: +358 3 5800 200  
info.finland@formica.com

**France**

Tel: +33 (0)1 60 06 86 86  
Tél échantillons +33 (0)1 60 06 86 23  
service.echantillons@formica.com

**Germany**

Tel: +49 (0) 180 367 64 22  
kontakt.deutschland@formica.com

**Holland**

Tel: +31 (0) 70 413 48 20  
contact.nederland@formica.com

**Ireland**

Tel: +353 1 872 4322  
samples.uk@formica.com

**Italy**

Tel: +39 02 9040121  
italia@formica.com

**Middle East**

Tel: +971 4 3298280  
middle.east@formica.com

**Norway**

Tel: +47 66 98 48 00  
info.norge@formica.com

**Poland**

Tel: +48 22 516 20 84/85  
info.polska@formica.com

**Russia**

Tel: +7 495 646 07 25  
russia@formica.com

**Spain**

Tel: +34 944 579 600  
Tel: +34 961 262 800  
sampling@formica.com

**Sweden**

Tel: +46 42 38 48 00  
info.sverige@formica.com

**Switzerland**

Tel: +41 44 818 88 18  
schweiz@formica.com

**United Kingdom**

Tel: +44 191 259 3100  
Samples tel: +44 191 259 3512  
samples.uk@formica.com



# formica.com

A **Fletcher**Building company